

Alt Piazza

Spec Guide

Issued June 2019

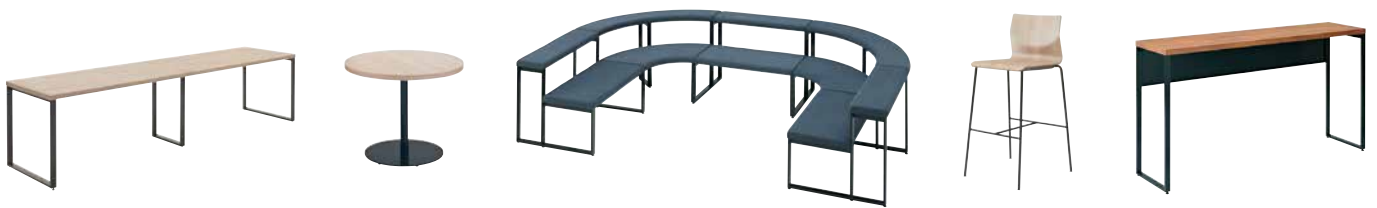

Furniture Collections for Collaboration

Alt Piazza is a collection of bars, tables, and complimentary seating that creates casual, open environments for collaboration and light work away from your desk. The cafe style work environment can be used for light work or informal collaboration. The casual setting encourages impromptu conversations and promotes well-being by giving workers more workspace options. The table and bar surfaces feature a unique woodgrain laminate—giving the aesthetic and texture of solid wood with the durability of a laminate.



Contents

- 1 Introduction
- 2 Colors
- 3 Statement of line
 - Standing Height Table
 - Standard Height Table
 - Single side-Standing Height Table
 - Side table
 - Cafe Table
 - Tiered Bench - Laminate seat
 - Tiered bench - Upholstered seat
- 4-leg Stacking Chair
- 4-leg High Stool
- 11 Typical configurations
- 13 Integrated Technology
- 15 Power Source Diagram
- 16 Recommended power outlet position and dedicated power source cable kit and dedicated power source cable kit
- 19 Electrical components
- 20 Typical configuration - Technology integration
- 21 Table with cutouts - for surface mount lightings
- 22 Surface mount lighting

Laminate Colors



Fabric Colors (Interlock)



Base Colors



Felt Cushion Colors

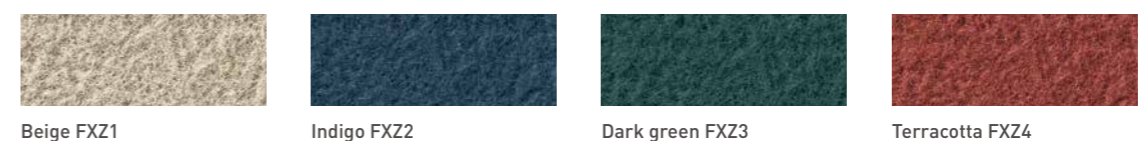

Standing Height Table
→3P



Cafe Table
→6P



Tiered Bench
→7P

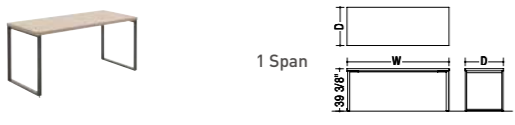
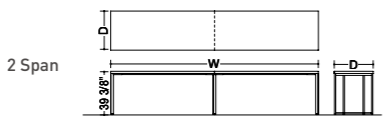
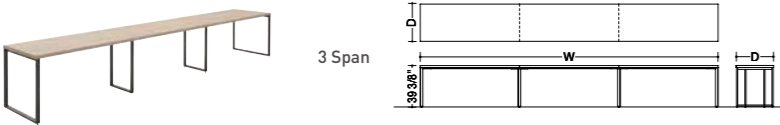

Standing Height Table

Span	Drawing	W	D	H	Base Color	Code
1 Span		70 7/8"	35 7/16"	39 3/8"	Black	MB2BDHN-M□□□
			White		MB3BDHN-M□□□	
			39 3/8"		Black	MB2BJHN-M□□□
			White		MB3BJHN-M□□□	
			35 7/16"		Black	MB2BEHN-M□□□
			White		MB3BEHN-M□□□	
		78 3/4"	35 7/16"	39 3/8"	Black	MB2BKHN-M□□□
			White		MB3BKHN-M□□□	
			39 3/8"		Black	MB2BFHN-M□□□
			White		MB3BFHN-M□□□	
			35 7/16"		Black	MB2BLHN-M□□□
			White		MB3BLHN-M□□□	
2 Span		141 3/4"	35 7/16"	39 3/8"	Black	MB2FDHN-M□□□
			White		MB3FDHN-M□□□	
			39 3/8"		Black	MB2FJHN-M□□□
			White		MB3FJHN-M□□□	
			35 7/16"		Black	MB2FFHN-M□□□
			White		MB3FFHN-M□□□	
		189"	35 7/16"	39 3/8"	Black	MB2FLHN-M□□□
			White		MB3FLHN-M□□□	
			39 3/8"		Black	MB2KEHN-M□□□
			White		MB3KEHN-M□□□	
			39 3/8"		Black	MB2KKHN-M□□□
			White		MB3KKHN-M□□□	
3 Span		236 1/4"	35 7/16"	39 3/8"	Black	MB2KEHN-M□□□
			White		MB3KEHN-M□□□	
			39 3/8"		Black	MB2KKHN-M□□□
			White		MB3KKHN-M□□□	

Common Specification : Laminated work surface(2" thick), Wire management trays, Steel frame with levelers

Standard Height Table

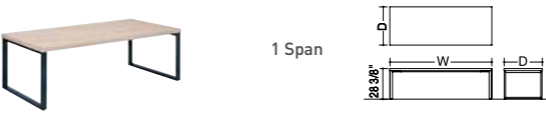
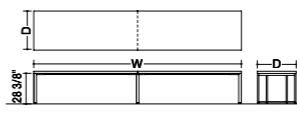
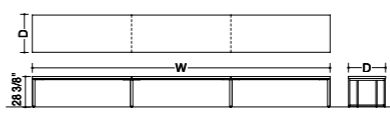
Span	Drawing	W	D	H	Base Color	Code
1 Span		70 7/8"	35 7/16"	28 3/8"	Black	MB26DLN-M□□□
			White		MB36DLN-M□□□	
			39 3/8"		Black	MB26JLN-M□□□
			White		MB36JLN-M□□□	
			35 7/16"		Black	MB26ELN-M□□□
			White		MB36ELN-M□□□	
		78 3/4"	35 7/16"	28 3/8"	Black	MB26KLN-M□□□
			White		MB36KLN-M□□□	
			39 3/8"		Black	MB26FLN-M□□□
			White		MB36FLN-M□□□	
			35 7/16"		Black	MB26LLN-M□□□
			White		MB36LLN-M□□□	
2 Span		141 3/4"	35 7/16"	28 3/8"	Black	MB2FDLN-M□□□
			White		MB3FDLN-M□□□	
			39 3/8"		Black	MB2FJLN-M□□□
			White		MB3FJLN-M□□□	
			35 7/16"		Black	MB2FFLN-M□□□
			White		MB3FFLN-M□□□	
		189"	35 7/16"	28 3/8"	Black	MB2FLN-M□□□
			White		MB3FLN-M□□□	
			39 3/8"		Black	MB2KELN-M□□□
			White		MB3KELN-M□□□	
			39 3/8"		Black	MB2KKLN-M□□□
			White		MB3KKLN-M□□□	
3 Span		236 1/4"	35 7/16"	28 3/8"	Black	MB2KELN-M□□□
			White		MB3KELN-M□□□	
			39 3/8"		Black	MB2KKLN-M□□□
			White		MB3KKLN-M□□□	

Common Specification : Laminated work surface(2" thick), Wire management trays, Steel frame with levelers

Seating capacity

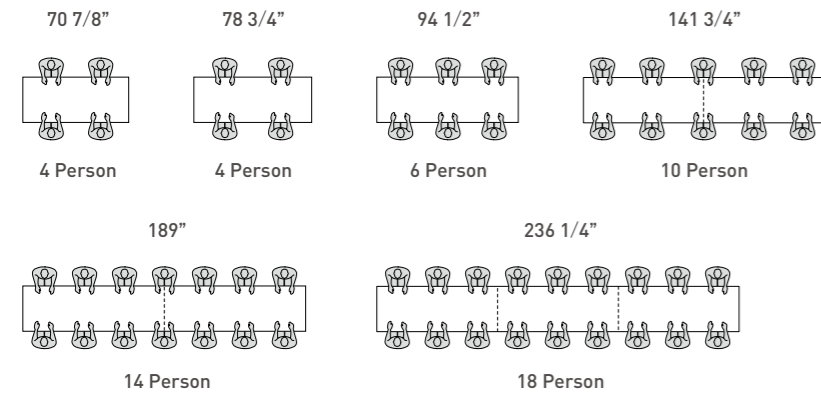

Laminate Colors							Base Colors	
Chalked elm MW71	Sawn oak MW72	Rustic pine MW73	Vintage elm MW74	Prize wood light MX51*	Prize wood medium MX52*	Prize wood dark MX53*	Black Z25	White ZA75

*Anti-fingerprint laminate

Laminate Colors							Base Colors	
Chalked elm MW71	Sawn oak MW72	Rustic pine MW73	Vintage elm MW74	Prize wood light MX51*	Prize wood medium MX52*	Prize wood dark MX53*	Black Z25	White ZA75

*Anti-fingerprint laminate

Single side-Standing Height Table

Drawing	W	D	H	Base Color	Code
	70 7/8"	17 3/4"	39 3/8"	Black	MB24JHN-M□□□
	59 1/16"			White	MB34JHN-M□□□
			Black	MB24CHN-M□□□	
			White	MB34CHN-M□□□	

Common Specification : Laminated work surface(1 9/16 " thick) , Steel modesty panel, Wire management tray, Steel frame with levelers

Side table

Drawing	Type	Dimension	H	Base Color	Code
	Standard height	17 3/4"W x 9 13/16"D	26 3/8"	Black	MB29AZN-M□□□
				White	MB39AZN-M□□□
	Low height	17 3/4"W x 9 13/16"D	21 5/8"	Black	MB29LZN-M□□□
				White	MB39LZN-M□□□

Common Specification : Laminated work surface , Steel tube post , Steel base with glides

Laminate Colors							Base Colors	
Chalked elm MW71	Sawn oak MW72	Rustic pine MW73	Vintage elm MW74	Prize wood light MX51*	Prize wood medium MX52*	Prize wood dark MX53*	Black Z25	White ZA75

*Anti-fingerprint laminate

Cafe Table

Drawing	Type	Dimension	H	Base Color	Code
	Rectangle *Rectangle base	25 9/16"W x 29 1/2"D	28 3/8"	Black	MB29AEN-M□□□
				White	MB39AEN-M□□□
	Square *23 5/8" round base	29 1/2" square	28 3/8"	Black	MB29BAN-M□□□
				White	MB39BAN-M□□□
	Round *23 5/8" round base	35 7/16" round	28 3/8"	Black	MB29AAN-M□□□
				White	MB39AAN-M□□□
		29 1/2" round		Black	MB29ABN-M□□□
				White	MB39ABN-M□□□
	Round *17 3/4" round base	23 5/8" round	28 3/8"	Black	MB29ACN-M□□□
		17 3/4" round		White	MB39ACN-M□□□
	Square *23 5/8" round base	29 1/2" square	19 11/16"	Black	MB29MAN-M□□□
				White	MB39MAN-M□□□
	Round *23 5/8" round base	35 7/16" round	19 11/16"	Black	MB29LAN-M□□□
				White	MB39LAN-M□□□
		29 1/2" round		Black	MB29LBN-M□□□
				White	MB39LBN-M□□□
	Round *17 3/4" round base	23 5/8" round	19 11/16"	Black	MB29LCN-M□□□
		17 3/4" round		White	MB39LCN-M□□□
	Round *17 3/4" round base	17 3/4" round	19 11/16"	Black	MB29LDN-M□□□
				White	MB39LDN-M□□□

Common Specification : Laminated work surface(1 9/16" thick), Steel tube post, Steel base with levelers

Laminate Colors							Base Colors	
Chalked elm MW71	Sawn oak MW72	Rustic pine MW73	Vintage elm MW74	Prize wood light MX51*	Prize wood medium MX52*	Prize wood dark MX53*	Black Z25	White ZA75

*Anti-fingerprint laminate

Tiered Bench - Laminate seat

Drawing		Type	W	D	H	Base Color	Code
		Straight bench	35 7/16"	17 3/4"	15 3/4"	Black	MB27ABN-M□□□
	White					MB37ABN-M□□□	
		Straight bench 2-3 Seater	63"	17 3/4"	15 3/4"	Black	MB27BBN-M□□□
	White					MB37BBN-M□□□	
						Black	MB27CBN-M□□□
						White	MB37CBN-M□□□
		Straight tiered	35 7/16"	27 9/16"	15 3/4"	Black	MB27AZN-M□□□
	White					MB37AZN-M□□□	
		Straight tiered 2 Seater	70 7/8"	27 9/16"	15 3/4"	Black	MB27AAN-M□□□
	White					MB37AAN-M□□□	
		Curved bench	43 1/8"	21 5/8"	15 3/4"	Black	MB27RBN-M□□□
	White					MB37RBN-M□□□	
		Inner curved tiered bench	56 3/4"	31 1/2"	15 3/4"	Black	MB27RZN-M□□□
	White					MB37RZN-M□□□	
		Outer curved tiered bench	56 3/4"	31 1/2"	15 3/4"	Black	MB27QBN-M□□□
	White					MB37QBN-M□□□	
		Curved tiered bench set S 3 Seater	115 3/4"	40 3/16"	15 3/4"	Black	MB27RSN-M□□□
	White					MB37RSN-M□□□	
		Curved tiered bench set M 6 Seater	115 3/4"	75 9/16"	15 3/4"	Black	MB27RMN-M□□□
	White					MB37RMN-M□□□	
		Curved tiered bench set L 8 Seater	115 3/4"	115 3/4"	15 3/4"	Black	MB27RLN-M□□□
	White					MB37RLN-M□□□	
		O-shape bench set	60 5/8"	60 5/8"	15 3/4"	Black	MB27RRN-M□□□
	White					MB37RRN-M□□□	

Common Specification : Laminated seat(1 9/16" thick) , Steel frame with levelers

Accessory

				Code
	Felt cushion (16 1/8" dia)			MB17ZZN-FXZ□
		Beige FXZ1	Indigo FXZ2	
		Dark green FXZ3	Terracotta FXZ4	

Tiered Bench - Upholstered seat

Drawing		Type	W	D	H	Base Color	Code
		Straight bench	35 7/16"	17 3/4"	15 3/4"	Black	MB27EBN-FXW□
						White	MB37EBN-FXW□
		Straight bench 2-3 Seater	63"	17 3/4"	15 3/4"	Black	MB27FBN-FXW□
						White	MB37FBN-FXW□
						Black	MB27GBN-FXW□
						White	MB37GBN-FXW□
		Straight tiered	35 7/16"	27 9/16"	15 3/4"	Black	MB27EZN-FXW□
						White	MB37EZN-FXW□
		Straight tiered 2 Seater	70 7/8"	27 9/16"	15 3/4"	Black	MB27EAN-FXW□
						White	MB37EAN-FXW□
		Curved bench	43 1/8"	21 5/8"	15 3/4"	Black	MB27TBN-FXW□
						White	MB37TBN-FXW□
		Inner curved tiered bench	56 3/4"	31 1/2"	15 3/4"	Black	MB27TZN-FXW□
						White	MB37TZN-FXW□
		Outer curved tiered bench	56 3/4"	31 1/2"	15 3/4"	Black	MB27SBN-FXW□
						White	MB37SBN-FXW□
		Curved tiered bench set S 3 Seater	115 3/4"	40 3/16"	15 3/4"	Black	MB27TSN-FXW□
						White	MB37TSN-FXW□
		Curved tiered bench set M 6 Seater	115 3/4"	75 9/16"	15 3/4"	Black	MB27TMN-FXW□
						White	MB37TMN-FXW□
		Curved tiered bench set L 8 Seater	115 3/4"	115 3/4"	15 3/4"	Black	MB27TLN-FXW□
						White	MB37TLN-FXW□
		O-shape bench set	60 5/8"	60 5/8"	15 3/4"	Black	MB27TRN-FXW□
						White	MB37TRN-FXW□

Common Specification : Upholstered seat (2 1/16" thick), Steel frame with levelers

Fabric Colors (Interlock)

Fabric Colors (Interlock)									Base Colors	
Gray FXW1	Beige FXW2	Dark brown FXW3	Indigo FXW4	Dark green FXW5	Terracotta FXW6	Yellow FXW7	Pale pink FXW8	Sage FXW9	Black Z25	White ZA75

4-leg Stacking Chair

Drawing	Height	Seat & Back	Frame Color	Laminate Color	Code
	Standard height	Laminate	Black	MW71 Chalked elm	L409ARN-MW71
				MW72 Sawn oak	L409ARN-MW72
				MW73 Rustic pine	L409ARN-MW73
				MW74 Vintage elm	L409ARN-MW74
				MX51 Prize wood light	L409ARN-MX51
				MX52 Prize wood medium	L409ARN-MX52
				MX53 Prize wood dark	L409ARN-MX53
				MW71 Chalked elm	L409ERN-MW71
				MW72 Sawn oak	L409ERN-MW72
				MW73 Rustic pine	L409ERN-MW73
				MW74 Vintage elm	L409ERN-MW74
				MX51 Prize wood light	L409ERN-MX51
				MX52 Prize wood medium	L409ERN-MX52
				MX53 Prize wood dark	L409ERN-MX53
					Standard height
MW72 Sawn oak	L409ATN-FXW□				
MW73 Rustic pine	L409AUN-FXW□				
MW74 Vintage elm	L409AWN-FXW□				
MX51 Prize wood light	L409AXN-FXW□				
MX52 Prize wood medium	L409AYN-FXW□				
MX53 Prize wood dark	L409AZN-FXW□				
MW71 Chalked elm	L409ESN-FXW□				
MW72 Sawn oak	L409ETN-FXW□				
MW73 Rustic pine	L409EUN-FXW□				
MW74 Vintage elm	L409EWN-FXW□				
MX51 Prize wood light	L409EXN-FXW□				
MX52 Prize wood medium	L409EYN-FXW□				
MX53 Prize wood dark	L409EZN-FXW□				
	Fully upholstered	-	Black		
			White	-	L409EVN-FXW□

Common Specification : Laminate applied plywood shell, Steel frame with swivel glides

*Stackable up to (4) chairs

Laminate Colors							Base Colors	
Chalked elm MW71	Sawn oak MW72	Rustic pine MW73	Vintage elm MW74	Prize wood light MX51*	Prize wood medium MX52*	Prize wood dark MX53*	Black Z25	White ZA75

*Anti-fingerprint laminate

Fabric Colors (Interlock)								
Gray FXW1	Beige FXW2	Dark brown FXW3	Indigo FXW4	Dark green FXW5	Terracotta FXW6	Yellow FXW7	Pale pink FXW8	Sage FXW9

4-leg High Stool

Drawing	Height	Seat & Back	Frame Color	Laminate Color	Code
	High stool	Laminate	Black	MW71 Chalked elm	L409BRN-MW71
				MW72 Sawn oak	L409BRN-MW72
				MW73 Rustic pine	L409BRN-MW73
				MW74 Vintage elm	L409BRN-MW74
				MX51 Prize wood light	L409BRN-MX51
				MX52 Prize wood medium	L409BRN-MX52
				MX53 Prize wood dark	L409BRN-MX53
				MW71 Chalked elm	L409FRN-MW71
				MW72 Sawn oak	L409FRN-MW72
				MW73 Rustic pine	L409FRN-MW73
				MW74 Vintage elm	L409FRN-MW74
				MX51 Prize wood light	L409FRN-MX51
				MX52 Prize wood medium	L409FRN-MX52
				MX53 Prize wood dark	L409FRN-MX53
					High stool
MW72 Sawn oak	L409BTN-FXW□				
MW73 Rustic pine	L409BUN-FXW□				
MW74 Vintage elm	L409BWN-FXW□				
MX51 Prize wood light	L409BXN-FXW□				
MX52 Prize wood medium	L409BYN-FXW□				
MX53 Prize wood dark	L409BZN-FXW□				
MW71 Chalked elm	L409FSN-FXW□				
MW72 Sawn oak	L409FTN-FXW□				
MW73 Rustic pine	L409FUN-FXW□				
MW74 Vintage elm	L409FVN-FXW□				
MX51 Prize wood light	L409FXN-FXW□				
MX52 Prize wood medium	L409FYN-FXW□				
MX53 Prize wood dark	L409FZN-FXW□				
	Fully upholstered	-	Black		
			White	-	L409FVN-FXW□

Common Specification : Laminate applied plywood shell, Steel frame with swivel glides

*High stools are NOT stackable

Laminate Colors							Base Colors	
Chalked elm MW71	Sawn oak MW72	Rustic pine MW73	Vintage elm MW74	Prize wood light MX51*	Prize wood medium MX52*	Prize wood dark MX53*	Black Z25	White ZA75

*Anti-fingerprint laminate

Fabric Colors (Interlock)								
Gray FXW1	Beige FXW2	Dark brown FXW3	Indigo FXW4	Dark green FXW5	Terracotta FXW6	Yellow FXW7	Pale pink FXW8	Sage FXW9

Typical configurations

Configuration A

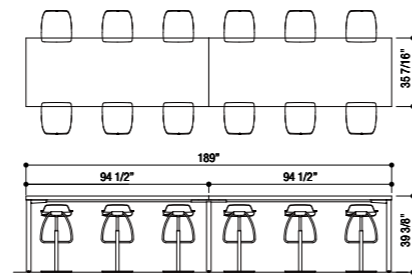
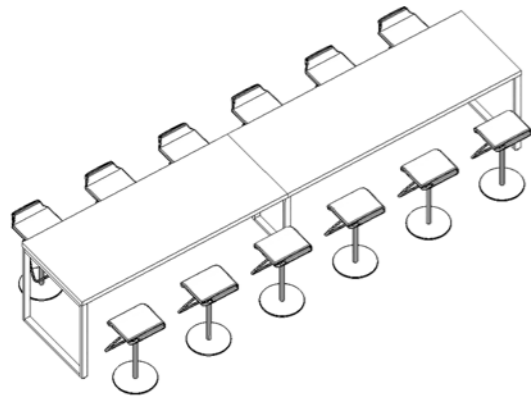

Description	Product No.	Quantity
Standing Height Table-2 Span (189"W 35 7/16"D)	MB2FFHN-M□□□	1
Swivel stool (Laminate seat)	L126RA-M□□□	12

Configuration B

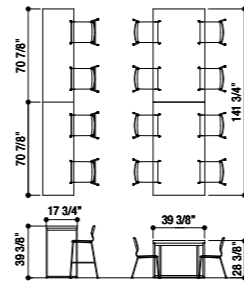
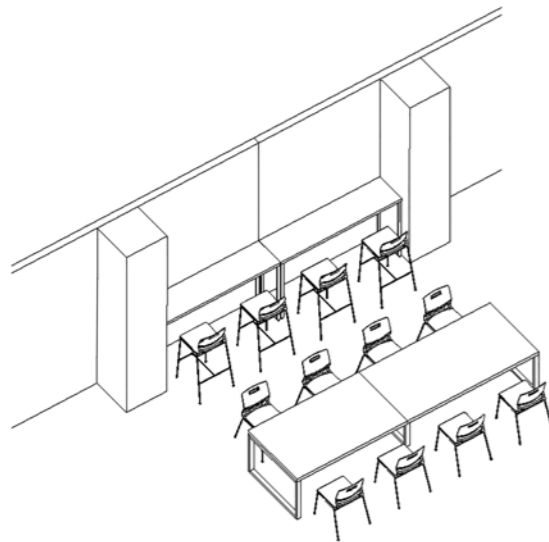

Description	Product No.	Quantity
Standard Height Table-2 Span (141 3/4"W 39 3/8"D)	MB2FJLN-M□□□	1
Single side-Standing Height Table (70 7/8"W 17 3/4"D)	MB24JHN-M□□□	2
4-leg Stacking Chair (Laminate seat)	L409ARN-M□□□	8
4-leg High Stool (Laminate seat)	L409BRN-M□□□	4

Configuration C

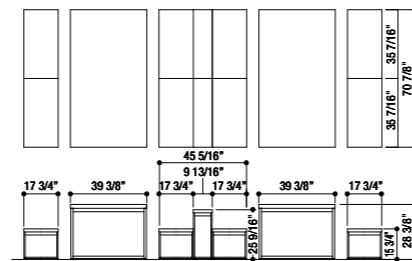
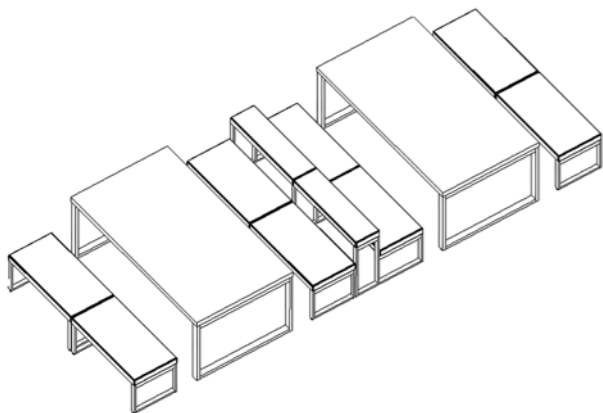

Description	Product No.	Quantity
Standard Height Table-1 Span (70 7/8"W 39 3/8"D)	MB26JLN-M□□□	2
Tiered bench - Upholstered seat (Straight bench - 35 7/16"W)	MB27EBN-FXW□	6
Tiered bench - Upholstered seat (Straight tiered 2 Seater - 70 7/8"W)	MB27AAN-M□□□	1

Configuration D

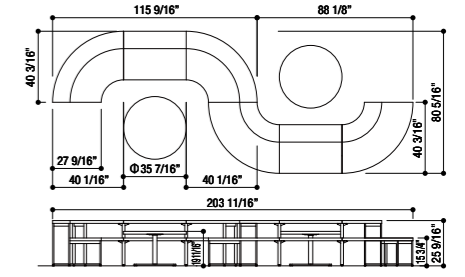
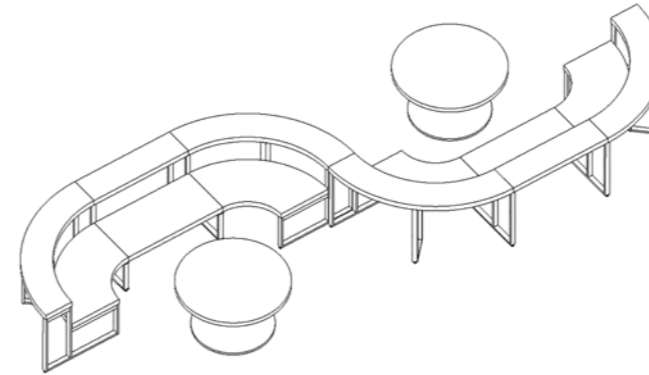

Description	Product No.	Quantity
Tiered Bench - Laminate seat (Curved tiered bench set S 3 Seater)	MB27RSN-M□□□	2
Cafe Table - 19 11/16"H 35 7/16" Round	MB29LAN-M□□□	2

Configuration E

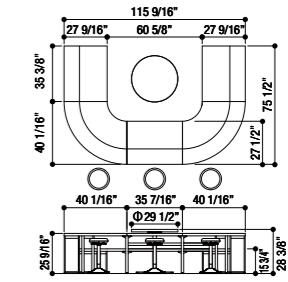
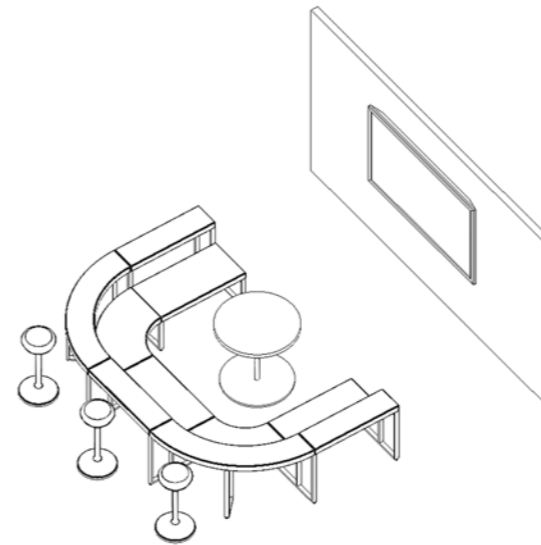

Description	Product No.	Quantity
Tiered bench - Upholstered seat (Curved tiered bench set M 6 Seater)	MB27TMN-M□□□	1
Repairing perching stool	81K3EA-FS□□/P□□□	3
Cafe Table - 28 3/8"H 29 1/2" Round	MB29ABN-M□□□	1

Configuration F

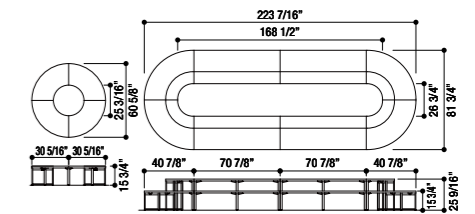
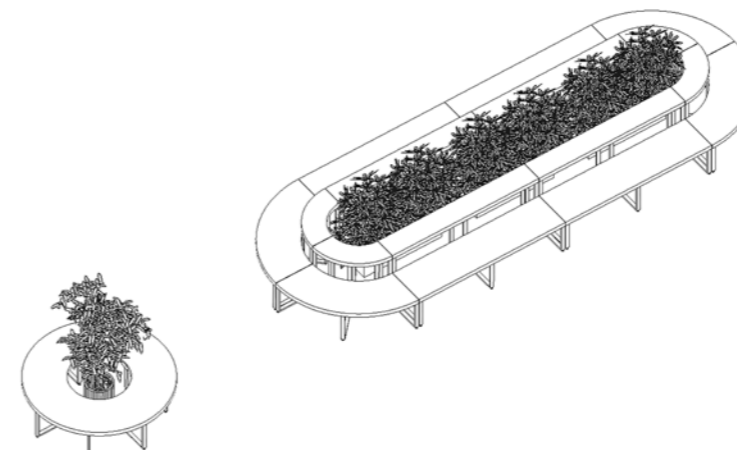

Description	Product No.	Quantity
Tiered Bench - Laminate seat (O-shape bench set)	MB27RRN-M□□□	1
Tiered Bench - Laminate seat (Outer curved tiered bench)	MB27QBN-M□□□	4
Tiered Bench - Laminate seat (Straight tiered 2 Seater)	MB27AAN-M□□□	4

Integrated Technology

Integrated technology is concealed within each design, yet allowing for future flexibility. Alt Piazza locates power outlets underneath the tabletop, making it easy to plug in while seated. Cables are hidden within the wiring ducts, and the wire management trays, ensuring a polished look and more usable space.

- A vertical wiring duct may be attached magnetically on any legs.
- Maintenance is easy with removable vertical wiring ducts and large capacity wire management trays.
- Alt Piazza comes with a large capacity wire management tray under the tabletop which can be used to store excess cables.
- Alt Piazza utilizes 4-wire, 2-circuit electrical module system for power sourcing.
- The power outlet and power source cable kit must be installed by a professional furniture installer.
- Alt Piazza has tables with pre-drilled cutouts as standard to allow an easy installation of surface-mount lightings.
- An arrangement of small wiring holes can be created on tabletop if specified.

Other Municipality Electrical Requirements

Metropolitan areas may have special electrical requirements. Consult a local electrical contractor for proper code compliance information.

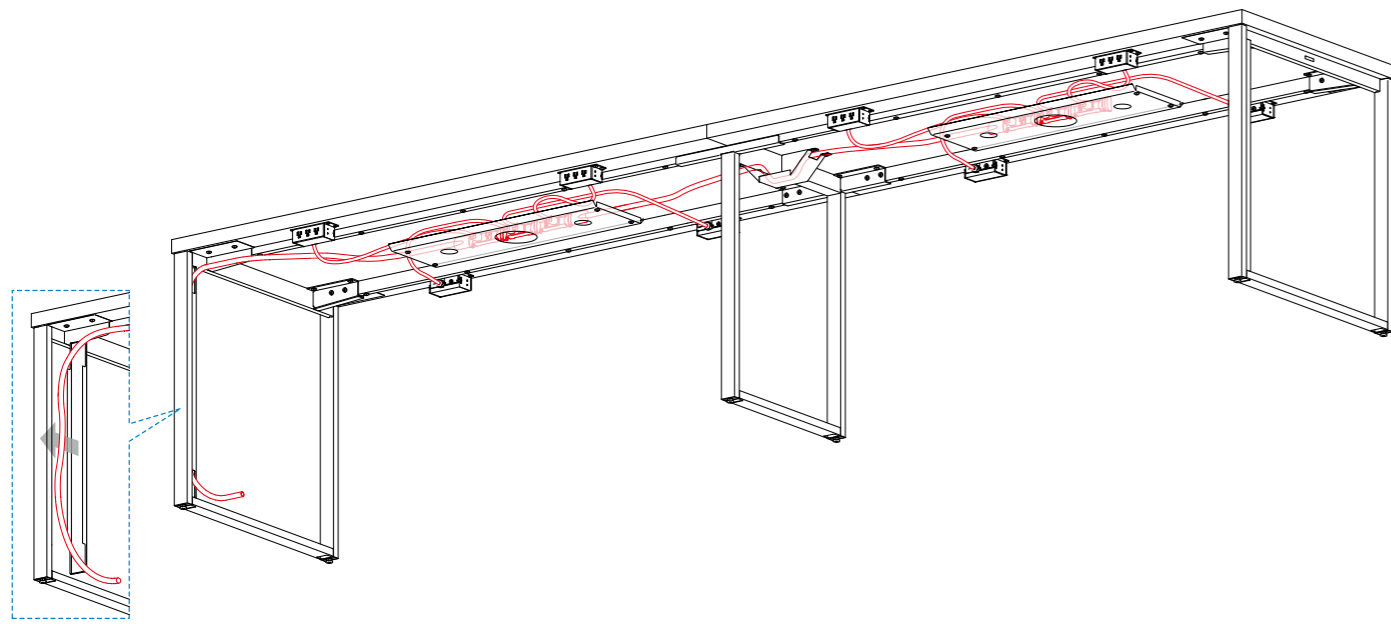

Proper vertical wiring duct per product

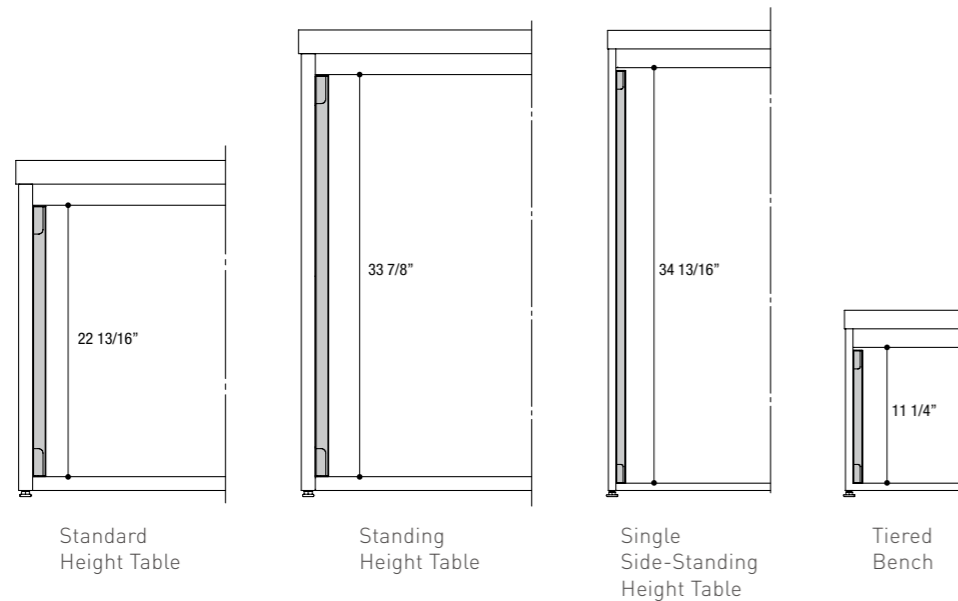

Wire routing details

Vertical wiring duct

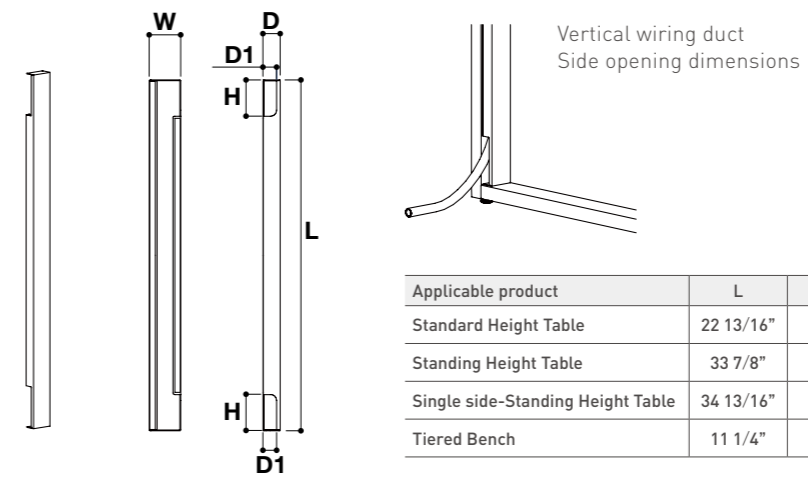

Horizontal wiring duct for Middle leg

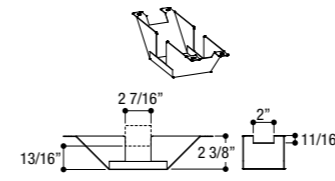

Wire management tray

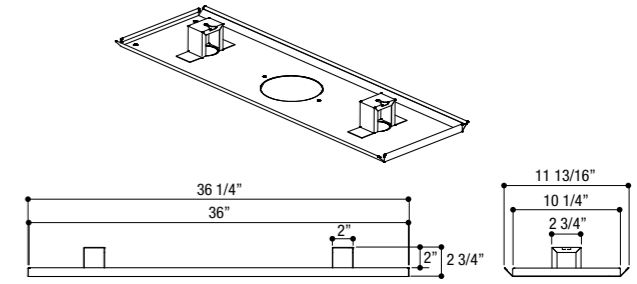

Vertical wiring duct position

Standing Height Table/Standard Height Table

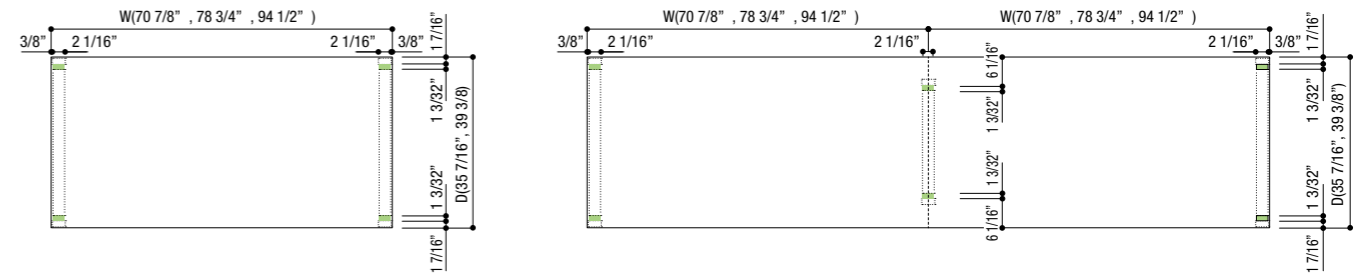

Single side - Standing Height Table



█ =Vertical wiring duct position

Power Source Diagram

- Utilizes 4-wire, 2-circuit electrical module system as power source for each power outlet.
- Each power outlet will be plugged in to receptacle block of electrical module system.
- All receptacle blocks are specified with only 1-circuit as standard. Receptacle blocks with 2-circuit can be ordered as an option.
- 20-amp hardwire power infeed is standard. A licensed electrician is required to complete hardwire connections to building's power source. Plug-in power infeed option available.
- 4-wire, 2-circuit electrical system supplied for standard hardwire infeed. Single circuit electrical system supplied for optional plug-in power infeed.
- All wires are 12 gauge
- The power outlet and power source cable kit are UL listed for upholding strict safety standards.

Electrical Diagram for Hardwire Power Infeed

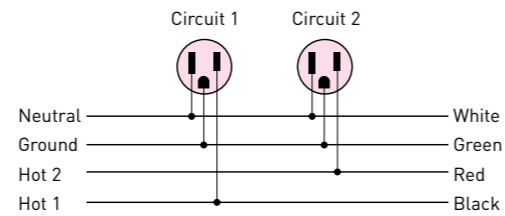

Note: For two circuits, Hot 1+2 should be connected to opposite sides of 240v bus

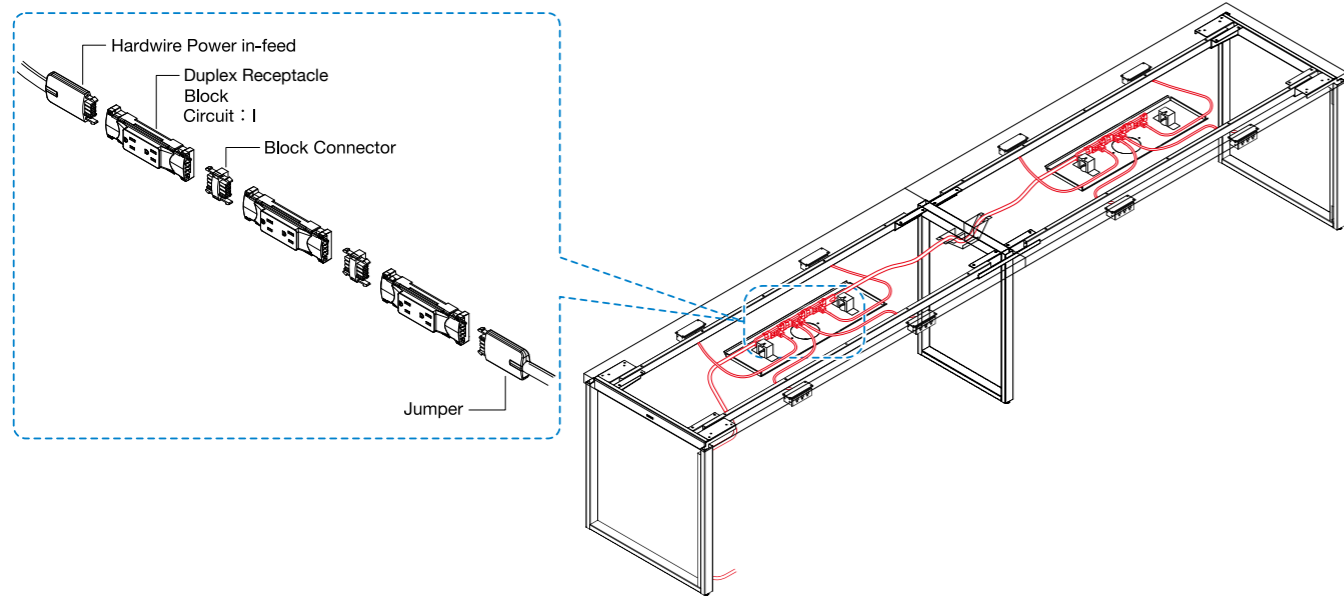

Recommended power outlet position

Dedicated power source cable kit

1 Span

Standing height table Dedicated Power source cable kit : MB18ADN-Y647

*Number of receptacles per cable kit : 6

Power source cable kit diagram – Wiring through end leg

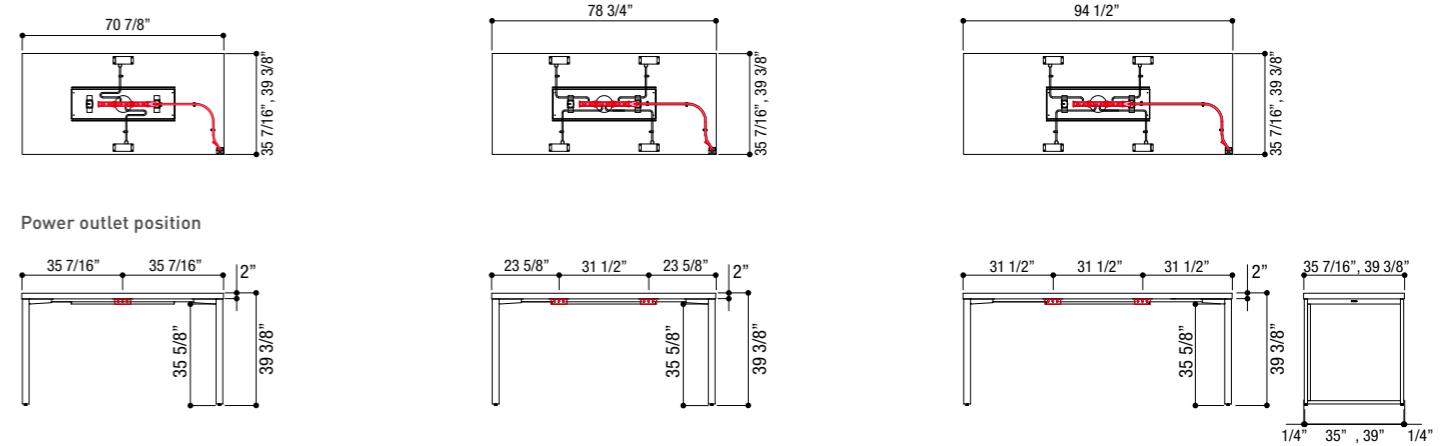

Applicable table item code

W	D	Base Color	Code
70 7/8"	35 7/16"	Black	MB2BDHN-M□□□
		White	MB3BDHN-M□□□
	39 3/8"	Black	MB2BJHN-M□□□
		White	MB3BJHN-M□□□

Applicable table item code

W	D	Base Color	Code
78 3/4"	35 7/16"	Black	MB2BEHN-M□□□
		White	MB3BEHN-M□□□
	39 3/8"	Black	MB2BKHN-M□□□
		White	MB3BKHN-M□□□

Applicable table item code

W	D	Base Color	Code
94 1/2"	35 7/16"	Black	MB2BFHN-M□□□
		White	MB3BFHN-M□□□
	39 3/8"	Black	MB2BLHN-M□□□
		White	MB3BLHN-M□□□

- MB18ADN-Y647
- Hardwire infeed 108" Qty:1
 - Duplex Receptacle block Black Circuit 1 Qty:3
 - Receptacle block connector Qty:2
 - Cable Management Clip - Package of 5 clips Qty:1

Power Outlet Mountable Area

Standing Height Table/Standard Height Table

■ = Power Outlet Mountable Area

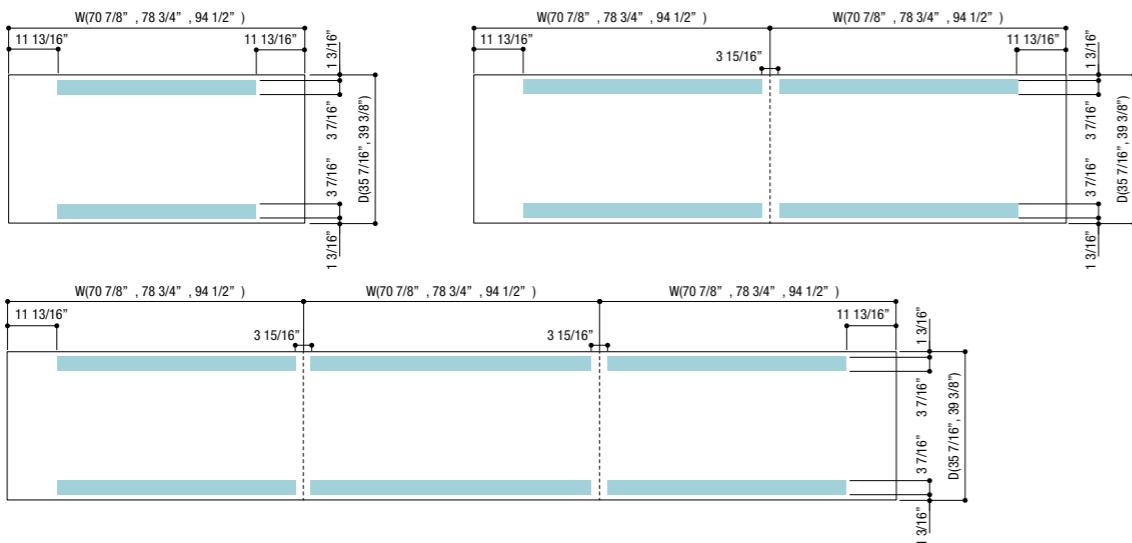

Single side - Standing Height Table

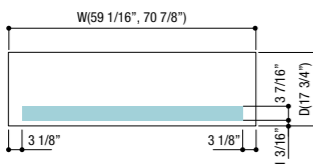

Standard height table Dedicated Power source cable kit : MB18BDN-Y647

*Number of receptacles per cable kit : 6

Power source cable kit diagram – Wiring through end leg

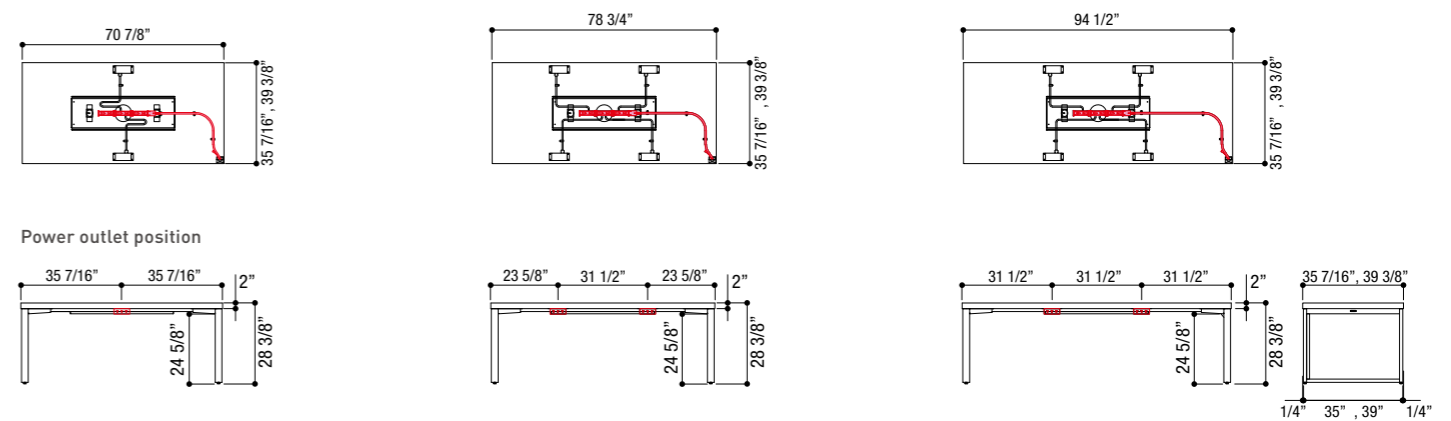

Applicable table item code

W	D	Base Color	Code
70 7/8"	35 7/16"	Black	MB26DLN-M□□□
		White	MB36DLN-M□□□
	39 3/8"	Black	MB26JLN-M□□□
		White	MB36JLN-M□□□

Applicable table item code

W	D	Base Color	Code
78 3/4"	35 7/16"	Black	MB26ELN-M□□□
		White	MB36ELN-M□□□
	39 3/8"	Black	MB26KLN-M□□□
		White	MB36KLN-M□□□

Applicable table item code

W	D	Base Color	Code
94 1/2"	35 7/16"	Black	MB26FLN-M□□□
		White	MB36FLN-M□□□
	39 3/8"	Black	MB26LLN-M□□□
		White	MB36LLN-M□□□

- MB18BDN-Y647
- Hardwire infeed 96" Qty:1
 - Duplex Receptacle block Black Circuit 1 Qty:3
 - Receptacle block connector Qty:2
 - Cable Management Clip - Package of 5 clips Qty:1

Standing height table

Dedicated Power source cable kit : MB18AEN-Y647

*Number of receptacles per cable kit : 12

Power source cable kit diagram – Wiring through end leg

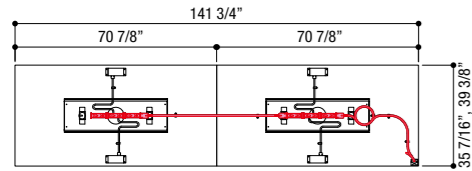

Power source cable kit diagram – Wiring through middle leg

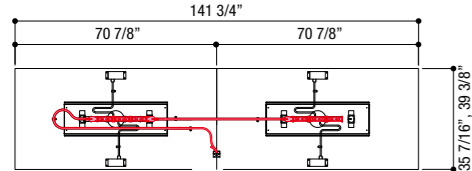

Power outlet position

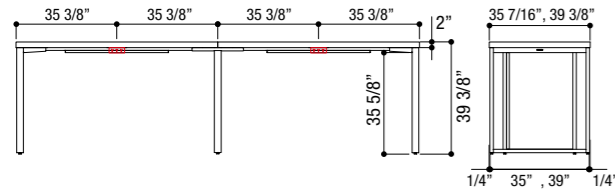

Applicable table item code

W	D	Base Color	Code
141 3/4"	35 7/16"	Black	MB2FDHN-M□□□
		White	MB3FDHN-M□□□
	39 3/8"	Black	MB2FJHN-M□□□
		White	MB3FJHN-M□□□

MB18AEN-Y647

- Hardwire infeed 144" Qty:1
- Duplex Receptacle block Black Circuit 1 Qty:6
- Receptacle block connector Qty:4
- Female/Female Jumper 72" Qty:1
- Cable Management Clip – Package of 5 clips Qty:2

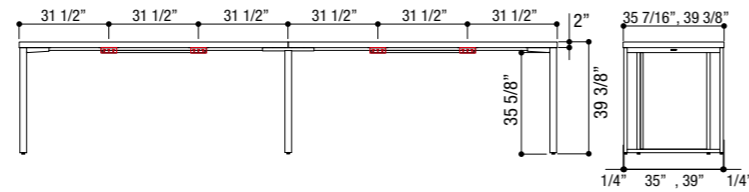
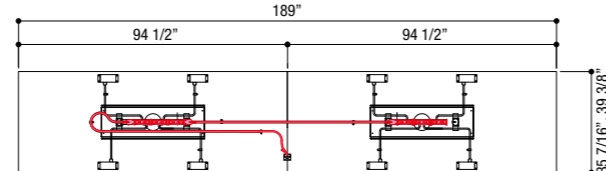
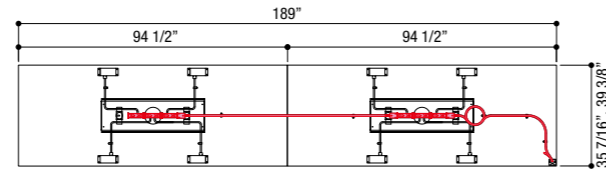

Applicable table item code

W	D	Base Color	Code
189"	35 7/16"	Black	MB2FFHN-M□□□
		White	MB3FFHN-M□□□
	39 3/8"	Black	MB2FLHN-M□□□
		White	MB3FLHN-M□□□

Standing height table

Dedicated Power source cable kit : MB18AFN-Y647

*Number of receptacles per cable kit : 18

Power source cable kit diagram – Wiring through end leg

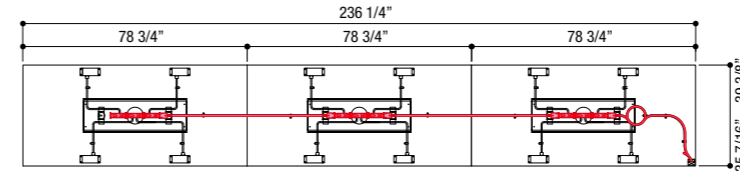

Power source cable kit diagram – Wiring through middle leg

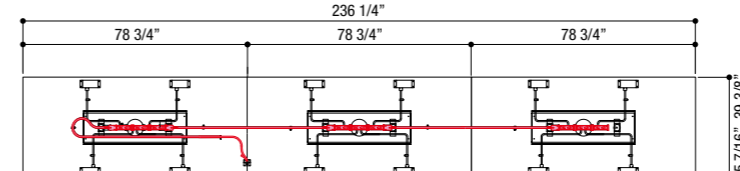

Power outlet position

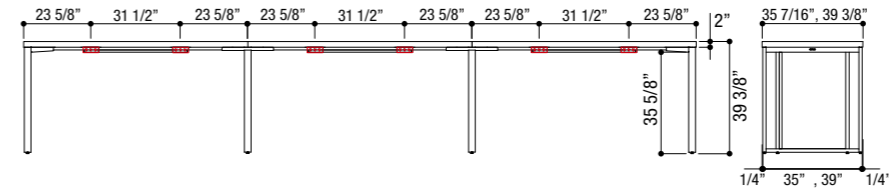

Applicable table item code

W	D	Base Color	Code
236 1/4"	35 7/16"	Black	MB2KEHN-M□□□
		White	MB3KEHN-M□□□
	39 3/8"	Black	MB2KKHN-M□□□
		White	MB3KKHN-M□□□

MB18AFN-Y647

- Hardwire infeed 144" Qty:1
- Duplex Receptacle block Black Circuit 1 Qty:9
- Receptacle block connector Qty:6
- Female/Female Jumper 72" Qty:2
- Cable Management Clip – Package of 5 clips Qty:3

Standard height table

Dedicated Power source cable kit : MB18BEN-Y647

*Number of receptacles per cable kit : 12

Power source cable kit diagram – Wiring through end leg

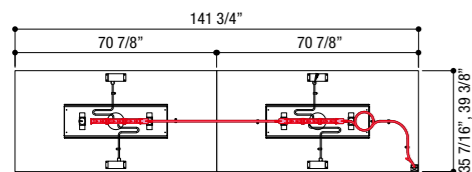

Power source cable kit diagram – Wiring through middle leg

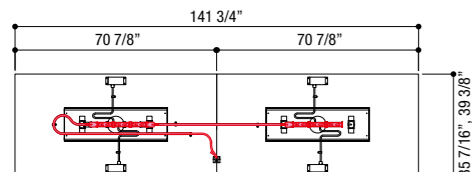

Power outlet position

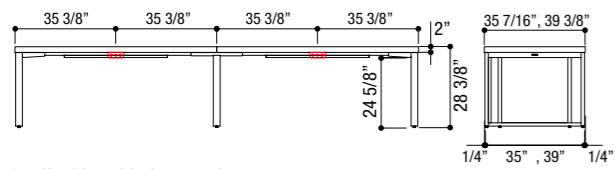

Applicable table item code

W	D	Base Color	Code
141 3/4"	35 7/16"	Black	MB2FDLN-M□□□
		White	MB3FDLN-M□□□
	39 3/8"	Black	MB2FJLN-M□□□
		White	MB3FJLN-M□□□

MB18BEN-Y647

- Hardwire infeed 120" Qty:1
- Duplex Receptacle block Black Circuit 1 Qty:6
- Receptacle block connector Qty:4
- Female/Female Jumper 72" Qty:1
- Cable Management Clip - Package of 5 clips Qty:2

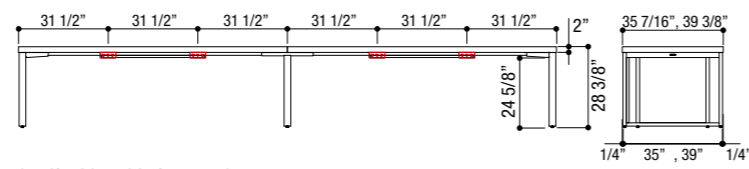
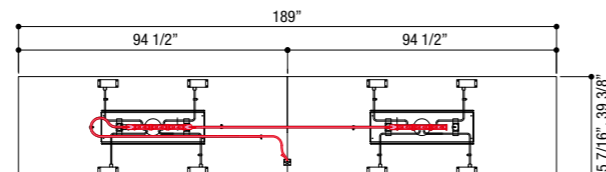
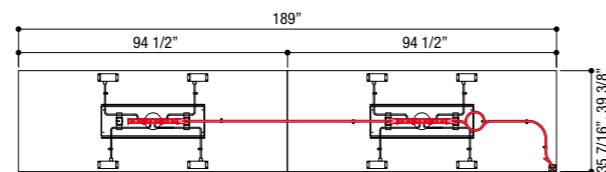

Applicable table item code

W	D	Base Color	Code
189"	35 7/16"	Black	MB2FFLN-M□□□
		White	MB3FFLN-M□□□
	39 3/8"	Black	MB2FLLN-M□□□
		White	MB3FLLN-M□□□

Standard height table

Dedicated Power source cable kit : MB18BFN-Y647

*Number of receptacles per cable kit : 18

Power source cable kit diagram – Wiring through end leg

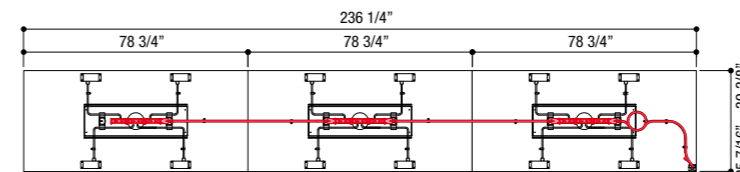

Power source cable kit diagram – Wiring through middle leg

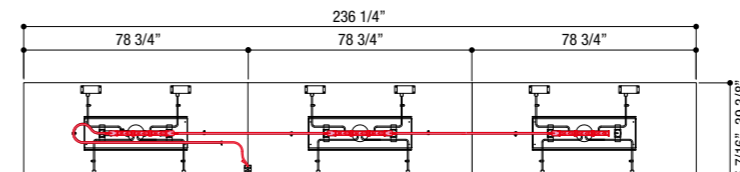

Power outlet position

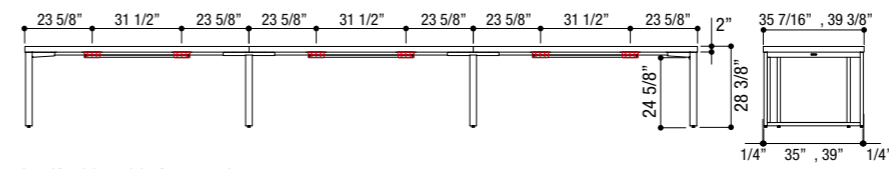

Applicable table item code

W	D	Base Color	Code
236 1/4"	35 7/16"	Black	MB2KELN-M□□□
		White	MB3KELN-M□□□
	39 3/8"	Black	MB2KKLN-M□□□
		White	MB3KKLN-M□□□



MB18BFN-Y647

- Hardwire infeed 120" Qty: 1
- Duplex Receptacle block Black Circuit 1 Qty:9
- Receptacle block connector Qty:6
- Female/Female Jumper 72" Qty:2
- Cable Management Clip - Package of 5 clips Qty:3

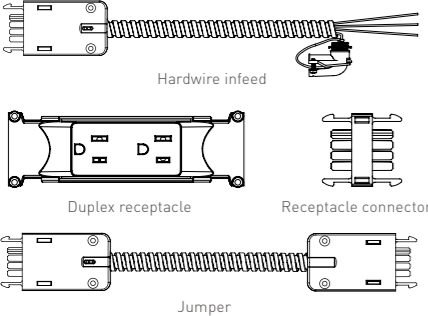
Electrical components

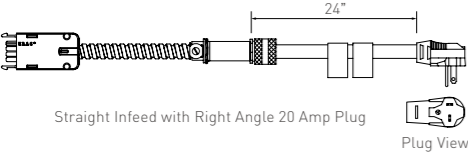
Power Source Cable Kit	Table Height	Span	Table Width	Number of Receptacles	Code	
	Standing Height Table 39 3/8"H		70 7/8"			
		1 Span	78 3/4"	6(2x3)	MB18ADN-Y647	
		2 Span	141 3/4"	12(2x6)	MB18AEN-Y647	
	Standard Height Table 28 3/8"H	3 Span	236 1/4"	18(2x9)	MB18AFN-Y647	
		1 Span	70 7/8"	78 3/4"	6(2x3)	MB18BDN-Y647
		2 Span	141 3/4"	12(2x6)	MB18BEN-Y647	
3 Span	236 1/4"	18(2x9)	MB18BFN-Y647			

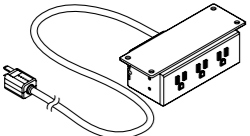
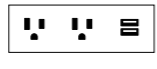
20 AMP Plug-in Power Entry Infeed (Optional)	Table Height	Span	Table Width	Infeed Length	Code
	Standing Height Table 39 3/8"H	1 Span	70 7/8" 78 3/4" 94 1/2"	108"	MB18CBN-Y647
		2 Span	141 3/4" 189"	120"	MB18CCN-Y647
		3 Span	236 1/4"		
	Standard Height Table 28 3/8"H	1 Span	70 7/8" 78 3/4" 94 1/2"	96"	MB18CAN-Y647
		2 Span	141 3/4" 189"	120"	MB18CCN-Y647
		3 Span	236 1/4"		

Power Outlet - Under mount	Configuration	Color	Code
		Black	MMD3BA-Y708
		White	MMD3BA-Y707
		Black	MMD3BB-Y708
		White	MMD3BB-Y707

Wiring Duct	Applicable Product	Color	Code
	Standing Height Table	Black	MB192PN-Z25
		White	MB192PN-ZA75
	Single side-Standing Height Table	Black	MB194PN-Z25
		White	MB194PN-ZA75
	Standard Height Table	Black	MB191PN-Z25
		White	MB191PN-ZA75
	Tiered Bench	Black	MB193PN-Z25
		White	MB193PN-ZA75

Cable guard	Applicable Product	Color	Code
	Standing Height Table	Black	DD287Z-G967
		Clear	DD287Z-G764
	Standard Height Table	Black	DD285Z-G967
		Clear	DD285Z-G764

Horizontal wiring duct for Middle leg	Color	Code
	Black	MB181PN-Z25
	White	MB181PN-ZA75

Typical configuration - Technology integration

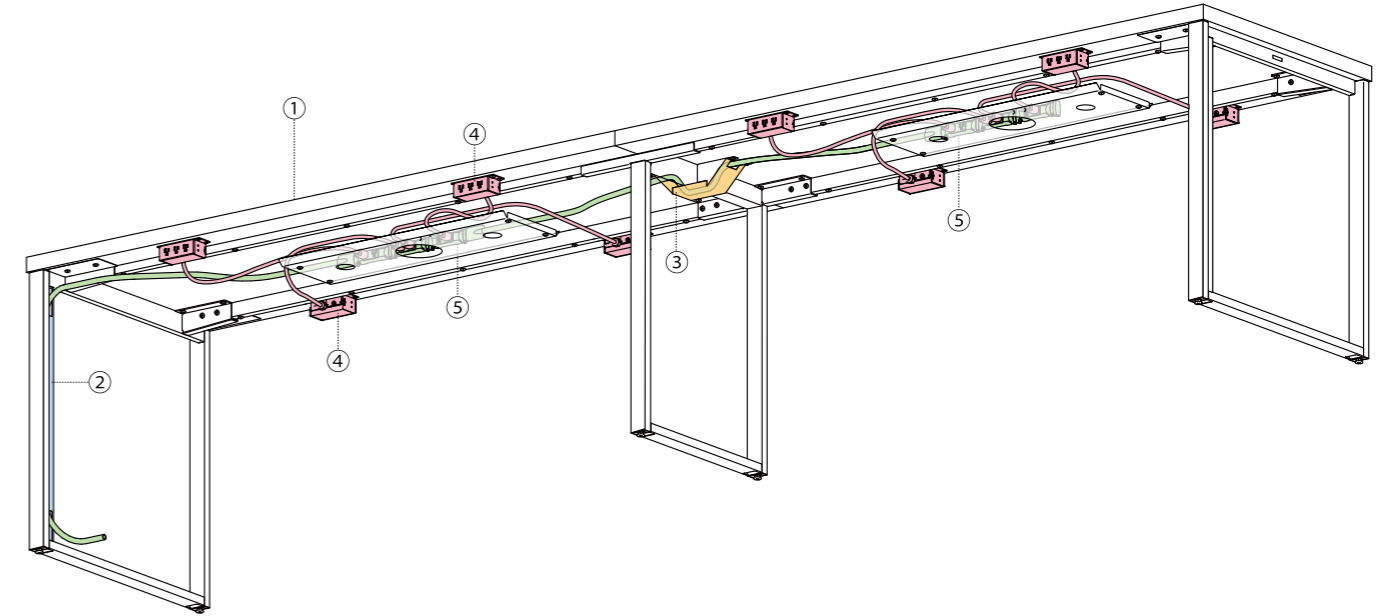

Case (Standing Height Table / 189"W 35 7/16"D / Black base

Description	Product No.	Quantity
① Standing Height Table (2 Span) 189"W 35 7/16"D	MB2FFHN-M□□□	1
② Vertical wiring duct (Black)	MB192PN-Z25	1
③ Horizontal wiring duct for Middle leg (Black)	MB181PN-Z25	1
④ Power Outlet 2 Power 1 Dual USB charger (Black)	MMD3BA-Y708	4
④ Power Outlet 3 Power (Black)	MMD3BB-Y708	4
⑤ Power Source Cable Kit	MB18AEN-Y647	1
20 AMP Plug-in Power Entry Infeed	MB18CCN-Y647	1

Table with cutouts - for surface mount lightings

Standing Height Table	Span	Drawing	W	D	H	Base Color	Code
	1 Span		70 7/8"	35 7/16"	39 3/8"	Black	MB2BDAN-M□□□
						White	MB3BDAN-M□□□
						Black	MB2BJAN-M□□□
	1 Span	78 3/4"	35 7/16"	39 3/8"	Black	MB2BEAN-M□□□	
					White	MB3BEAN-M□□□	
					Black	MB2BKAN-M□□□	
		94 1/2"	35 7/16"	39 3/8"	White	MB3BKAN-M□□□	
					Black	MB2BFAN-M□□□	
					White	MB3BFAN-M□□□	
	2 Span	141 3/4"	35 7/16"	39 3/8"	Black	MB2FDAN-M□□□	
					White	MB3FDAN-M□□□	
					Black	MB2FJAN-M□□□	
	2 Span	189"	35 7/16"	39 3/8"	White	MB3FJAN-M□□□	
					Black	MB2FFAN-M□□□	
					White	MB3FFAN-M□□□	
		236 1/4"	35 7/16"	39 3/8"	Black	MB2FLAN-M□□□	
					White	MB3FLAN-M□□□	
					Black	MB2KEAN-M□□□	
3 Span	236 1/4"	35 7/16"	39 3/8"	White	MB3KEAN-M□□□		
				Black	MB2KKAN-M□□□		
				White	MB3KKAN-M□□□		

Common Specification : Laminated work surface[2" thick], Wire management trays, Steel frame with levelers

Standard Height Table	Span	Drawing	W	D	H	Base Color	Code	
	1 Span	70 7/8"	70 7/8"	35 7/16"	39 3/8"	Black	MB26DBN-M□□□	
						White	MB36DBN-M□□□	
						Black	MB26JBN-M□□□	
		1 Span	78 3/4"	35 7/16"	28 3/8"	39 3/8"	White	MB36JBN-M□□□
							Black	MB26EBN-M□□□
							White	MB36EBN-M□□□
			94 1/2"	35 7/16"	28 3/8"	39 3/8"	Black	MB26KBN-M□□□
							White	MB36KBN-M□□□
							Black	MB26FBN-M□□□
	2 Span	141 3/4"	35 7/16"	28 3/8"	39 3/8"	White	MB36FBN-M□□□	
						Black	MB26LBN-M□□□	
						White	MB36LBN-M□□□	
		189"	35 7/16"	28 3/8"	39 3/8"	Black	MB2FDBN-M□□□	
						White	MB3FDBN-M□□□	
						Black	MB2FJBN-M□□□	
	3 Span	236 1/4"	35 7/16"	28 3/8"	39 3/8"	White	MB3FJBN-M□□□	
						Black	MB2FFBN-M□□□	
						White	MB3FFBN-M□□□	
		236 1/4"	35 7/16"	28 3/8"	39 3/8"	Black	MB2FLBN-M□□□	
						White	MB3FLBN-M□□□	
						Black	MB2KEBN-M□□□	
	3 Span	236 1/4"	35 7/16"	28 3/8"	39 3/8"	White	MB3KEBN-M□□□	
						Black	MB2KKBN-M□□□	
						White	MB3KKBN-M□□□	

Common Specification : Laminated work surface[2" thick], Wire management trays, Steel frame with levelers

Laminate Colors							Base Colors	
Chalked elm MW71	Sawn oak MW72	Rustic pine MW73	Vintage elm MW74	Prize wood light MX51*	Prize wood medium MX52*	Prize wood dark MX53*	Black Z25	White ZA75

*Anti-fingerprint laminate

Surface mount LED lighting

	USB charger	W	D	H	Code
	without USB charger	12"	12"	26 1/8"	DD64UAN-ZL□□
	with USB charger	12"	12"	26 1/8"	DD64UBN-ZL□□

Lighting Colors

Black ZL25	White ZL75

Specifications

Peak footcandles:	110
Color temperature:	2700K
Color rendering index:	90
Brightness adjustability:	100%—15% continuous
Automatic turn off:	after 10 hours
Materials:	aluminum and steel
Power supply:	60 watt power supply
Cord:	11' black cord
USB dedicated charge port:	Type-A connector, 5V, 2.1A
Certifications:	ETL listed: compliant to UL 153/8750 & CSA C22.2 No. 250.4; FCC Part 15 class B; TAA; CEC Title 20

Lighting mounting position

1 Span	2 Span	3 Span

*Other lighting position/qty may be specified as custom.

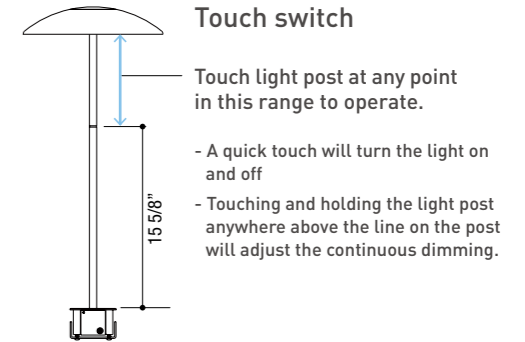

OKamura

OKAMURA CORPORATION

International Sales & Marketing Div.

2-14-27, Akasaka, Minato-ku, Tokyo 107-0052, JAPAN

Tel: +81-3-5561-4085 Fax: +81-3-5561-4086

<https://www.okamura.com/>

The products listed in this catalog are available as of August 2019. Please note that specifications, dimensions, and colors are subject to change without notice. The colors of the actual products may differ somewhat from the colors shown in the catalog, depending on printing conditions.

YOCK74-981