

Manifold

Spec Guide

Issued April 2018



About Us

In Okamura, we have been providing high quality products and services to our customers since the establishment. We integrate collective expertise and technology from all of our business domains from beginning of development to the end of manufacturing.

Who We Are

Now and in the future, quality that is the pride of Japan.

Okamura has continued to develop along with the Japanese business scene. Always taking into consideration social trends, our goal has been the creation of discretionary-use products adapted to the era and its work styles. As a company in the position of supporting the Japanese business world, our pursuit of that goal will not change. We will help create the society of tomorrow by further polishing our world-class made-in-Japan quality.

Manufacturing

Okamura Production System:

The Okamura Production System (OPS) is based on the Toyota Production System (TPS) and is Okamura's own developed production method. The Okamura Group views OPS as an ongoing activity in which all employees participate. OPS improvement activities are aimed at enhancing productivity and eliminating the wasting of resources and energy.



Instruction Manual

**Caution**

This indicates that improper handling may cause injury or property damage.

**Caution**

- Secure enough workspace before assembly. Failure to do so may cause injury.
- Assembly must be conducted by two or more people. Failure to do so may cause injury.
- Use specified tools for assembly. Improper assembly, such as not completely tightening screws, may cause damage to the product or cause the product to flip resulting in injury.
- Take gloves off when using power tools. Gloves may get caught in tools causing injury.
- Be careful when handling the ends and sacks of the parts, and with the gaps in between them. Failure to do so may cause injury.

Types of Workstation

The manifold has various types of workstations.

Bench Tables

P006-007

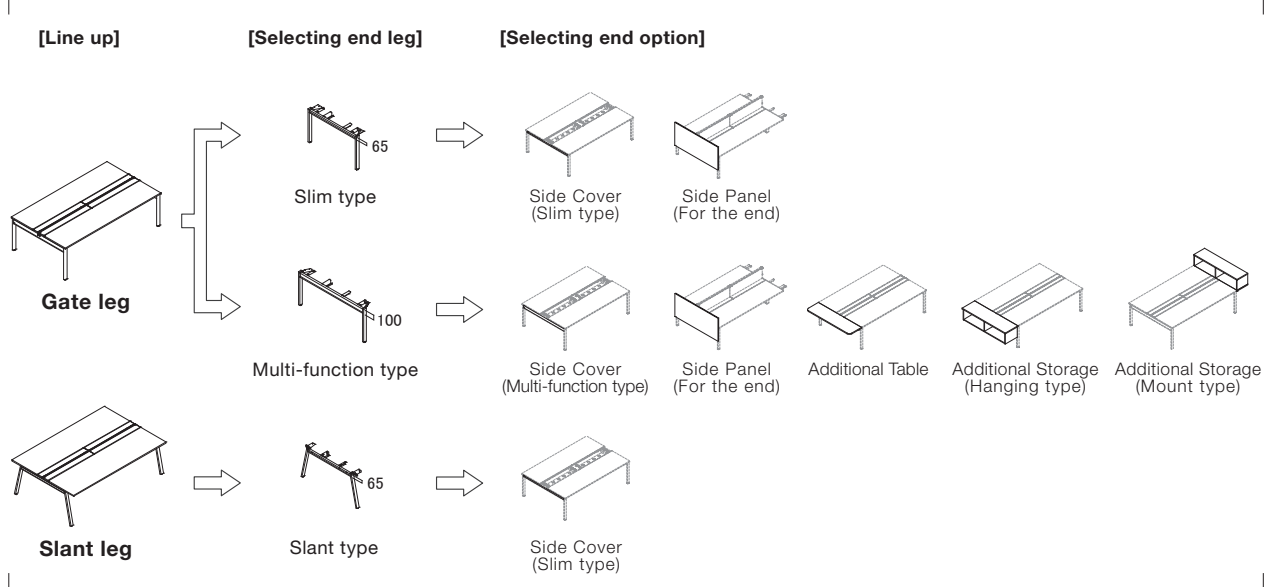

Free Standing Tables

P008

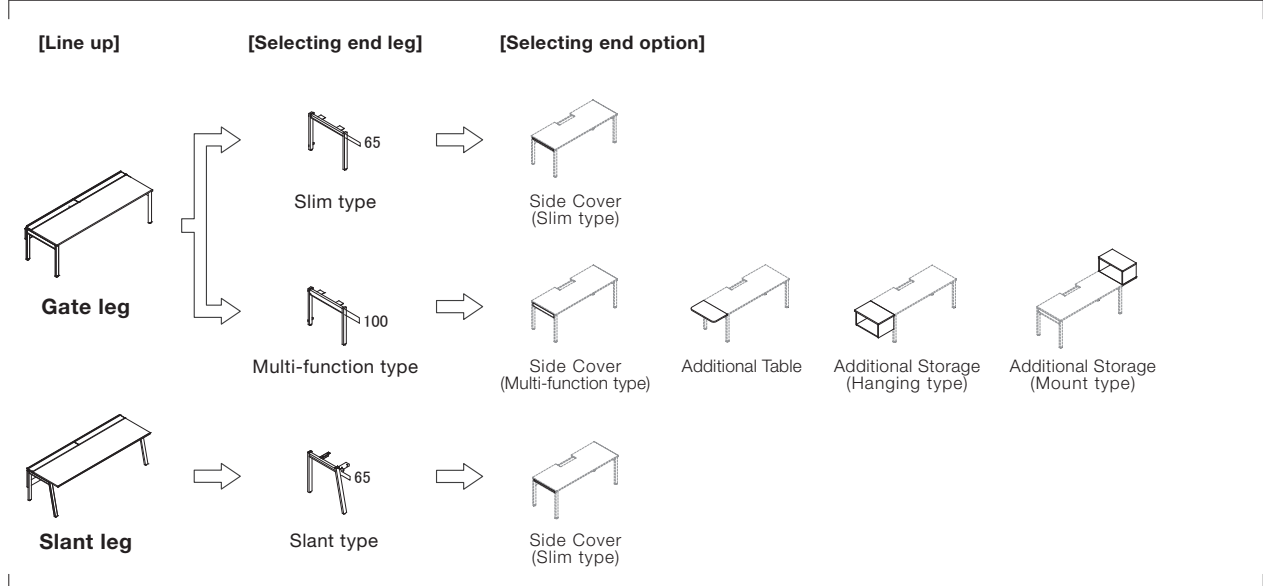

Meeting-tables / High-tables

P009



Types of Workstation

Option

[For center rail type]

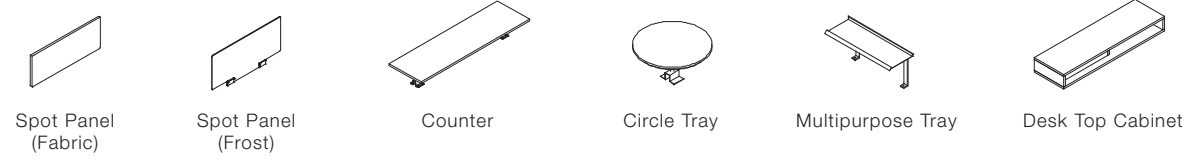

[For desktop panel type]

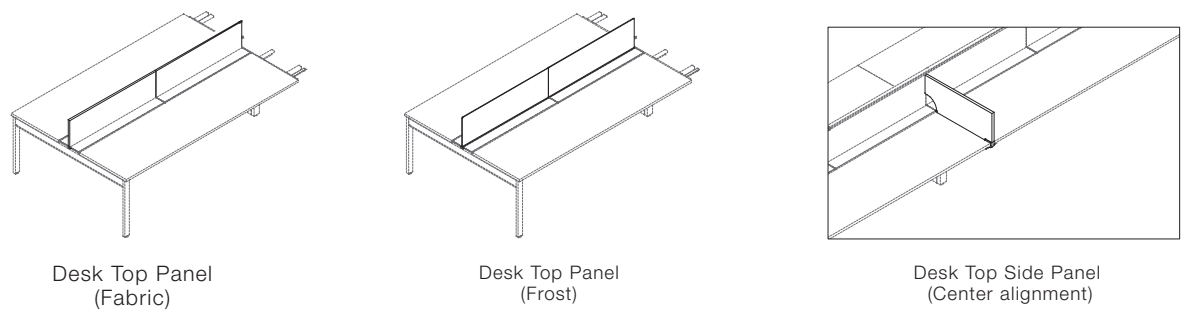

[For end option]

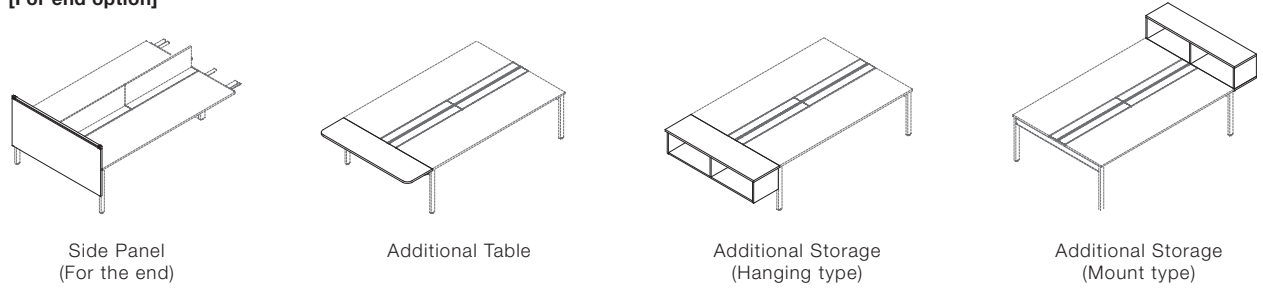

[Other]

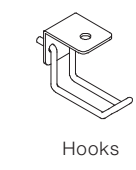

Wagon

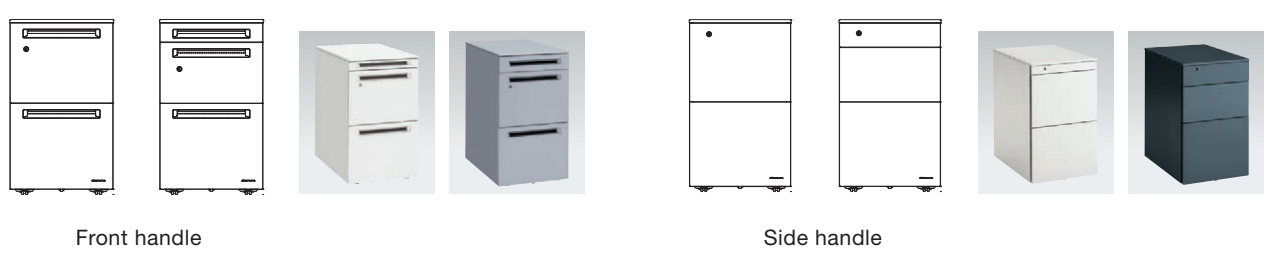

Types of Workstation

Bench tables Standard | Custom

TWO-sided

		Standard	Custom
Wiring style		Line wiring 	Hole wiring
	Leg style		
Gate leg		1400D 1600D (A)	1400D 1602D (B)
Slant leg		1400D 1600D (C)	1400D 1601D (D)

*For the hole wiring, see the page 10.

Standard

Custom

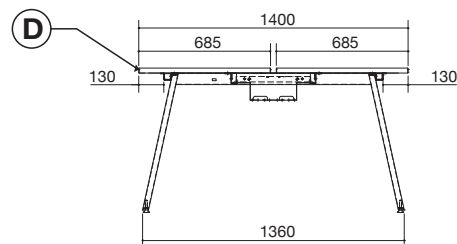
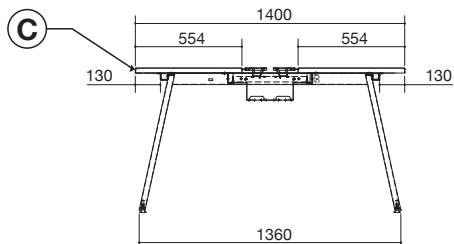
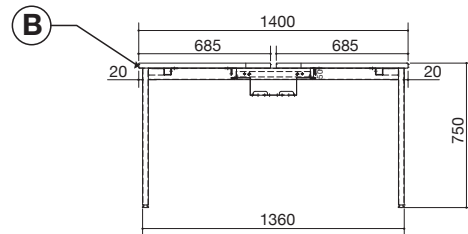
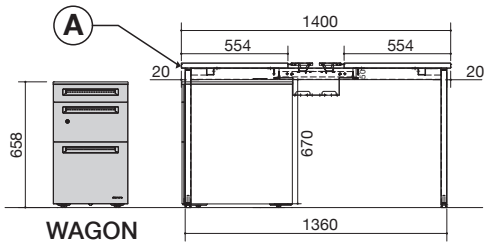
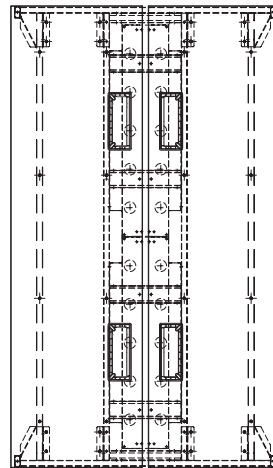
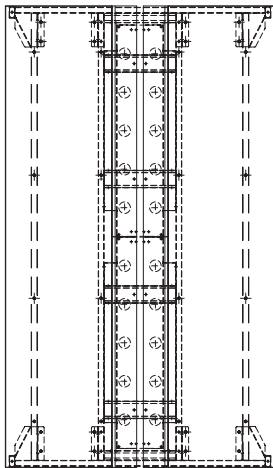

Types of Workstation

Table Top Design | Custom

Non over hang

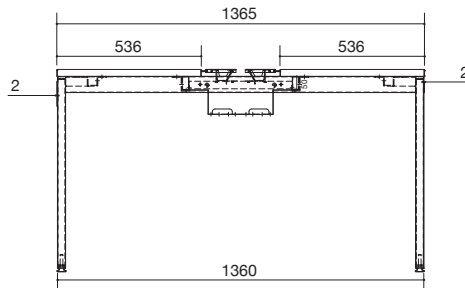
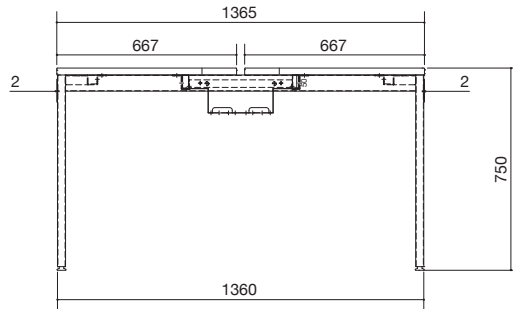
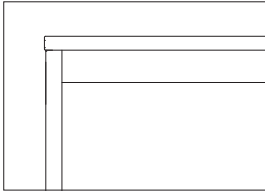

Knife edge

Gate leg

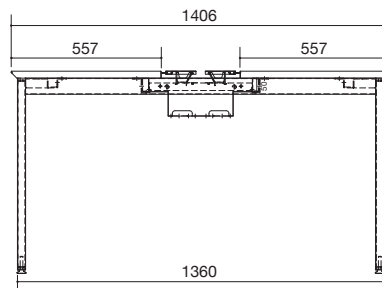
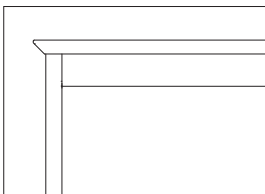

Slant leg

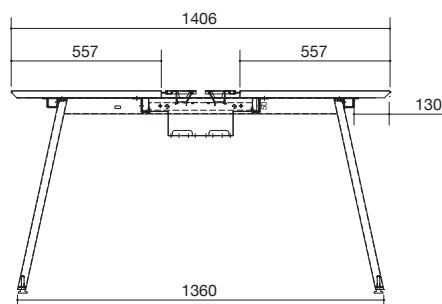
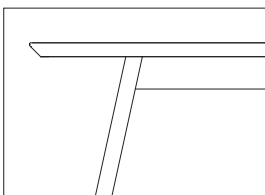

Types of Workstation

Free Standing Tables Standard | Custom

ONE-sided

	Standard	Custom	Custom
Wiring style			
Leg style			
Gate leg 	700D 800D E	700D 800D F	700D 800D G
Slant leg 	700D 800D H	700D 800D I	700D 800D J

*For the hole wiring, see the page 11.

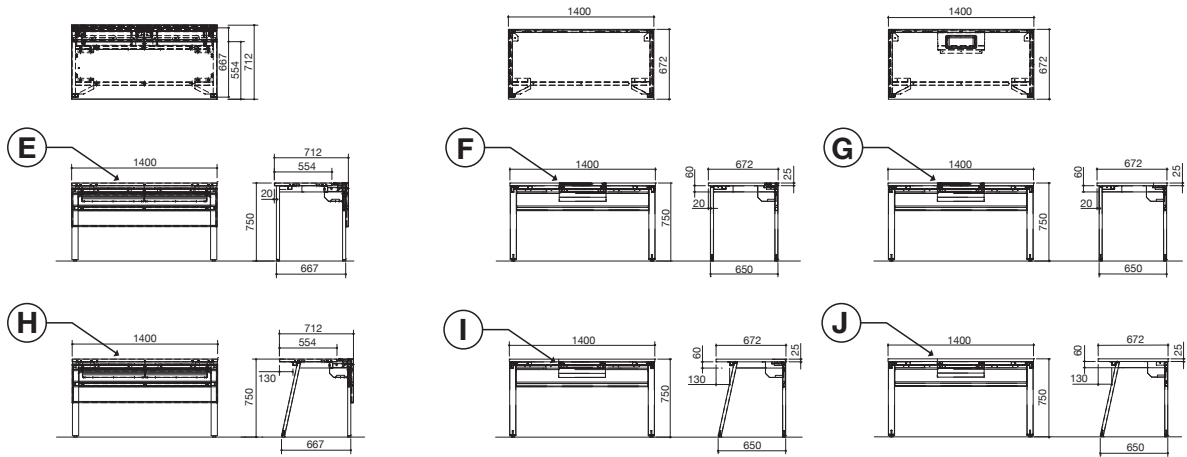
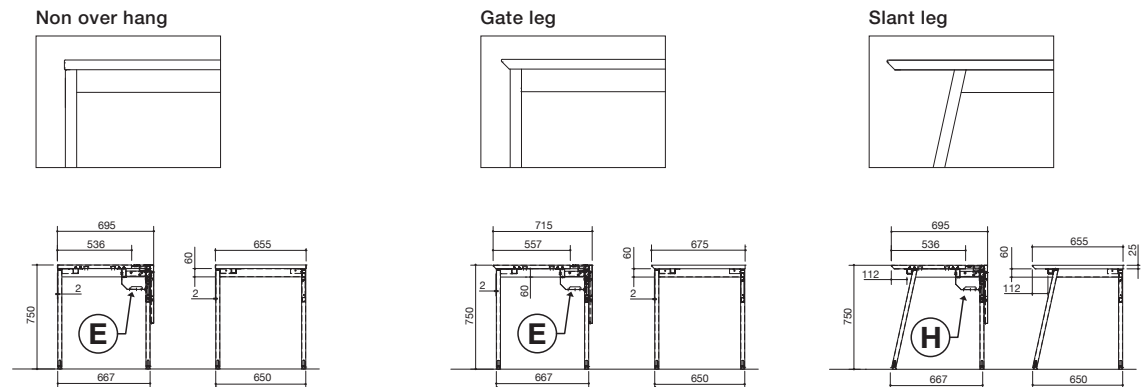

Table Top Design | Custom



Types of Workstation

Meeting-tables | Custom

Wiring style		
Leg style		
	900D (K)	900D (L)

High-tables | Custom

Wiring style		
Leg style		
	900D 1200D (M)	900D 1200D (N)

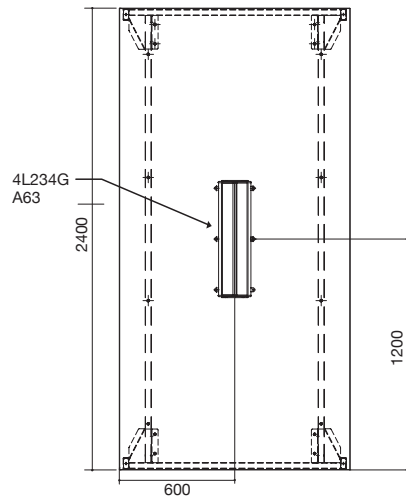
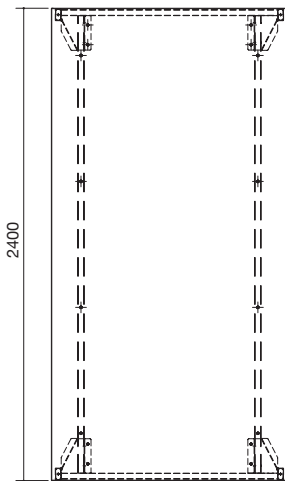

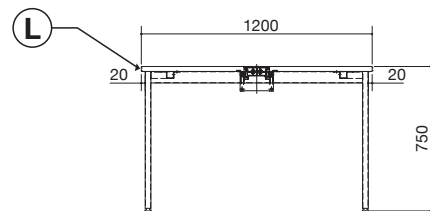
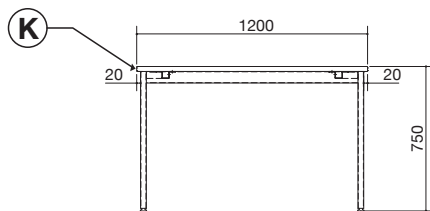

Meeting-tables



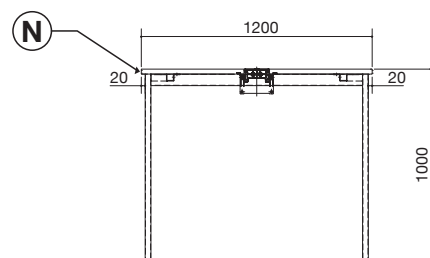
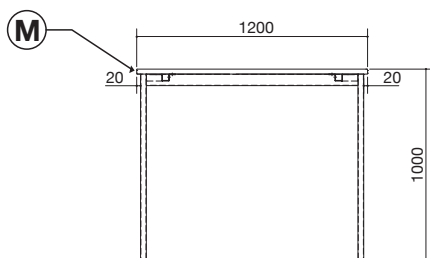

High-tables

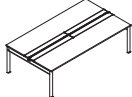
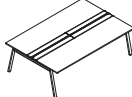
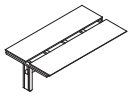

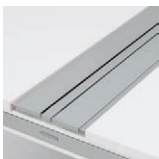
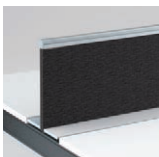
Line-up & Spec

			Free standing type				Joint type	
			Gate leg		Slant leg		Gate / Slant leg	
			Slim type					
TWO-sided (Standard)								
Center option	W	D	Item number	Color	Item number	Color	Item number	Color
 Center rail type	2400	1400	3LSABF	MX□	3LSGBF	MX□	3LSXBF	MX□
	2000		3LSABE	MX□	3LSGBE	MX□	3LSXBE	MX□
	1800		3LSABD	MX□	3LSGBD	MX□	3LSXBD	MX□
	1600		3LSABC	MX□	3LSGBC	MX□	3LSXBC	MX□
	1400		3LSABB	MX□	3LSGBB	MX□	3LSXBB	MX□
	1200		3LSABA	MX□	3LSGBA	MX□	3LSXBA	MX□
	2400	1600	3LSACF	MX□	3LSGCF	MX□	3LSXCF	MX□
	2000		3LSACE	MX□	3LSGCE	MX□	3LSXCE	MX□
	1800		3LSACD	MX□	3LSGCD	MX□	3LSXCD	MX□
	1600		3LSACC	MX□	3LSGCC	MX□	3LSXCC	MX□
	1400		3LSACB	MX□	3LSGCB	MX□	3LSXCB	MX□
	1200		3LSACA	MX□	3LSGCA	MX□	3LSXCA	MX□
 Center cover type	2400	1400	3LSBBF	MX□	3LSHBF	MX□	3LSYBF	MX□
	2000		3LSBBE	MX□	3LSHBE	MX□	3LSYBE	MX□
	1800		3LSBBD	MX□	3LSHBD	MX□	3LSYBD	MX□
	1600		3LSBBC	MX□	3LSHBC	MX□	3LSYBC	MX□
	1400		3LSBBB	MX□	3LSHBB	MX□	3LSYBB	MX□
	1200		3LSBBA	MX□	3LSHBA	MX□	3LSYBA	MX□
	2400	1600	3LSBCF	MX□	3LSHCF	MX□	3LSYCF	MX□
	2000		3LSBCE	MX□	3LSHCE	MX□	3LSYCE	MX□
	1800		3LSBCD	MX□	3LSHCD	MX□	3LSYCD	MX□
	1600		3LSBCC	MX□	3LSHCC	MX□	3LSYCC	MX□
	1400		3LSBCB	MX□	3LSHCB	MX□	3LSYCB	MX□
	1200		3LSBCA	MX□	3LSHCA	MX□	3LSYCA	MX□
 Desktop panel	2400	1400	3LSFBF	MX□	3LSJBF	MX□	3LSZBF	MX□
	2000		3LSFBE	MX□	3LSJBE	MX□	3LSZBE	MX□
	1800		3LSFBD	MX□	3LSJBD	MX□	3LSZBD	MX□
	1600		3LSFBC	MX□	3LSJBC	MX□	3LSZBC	MX□
	1400		3LSFBB	MX□	3LSJBB	MX□	3LSZBB	MX□
	1200		3LSFBA	MX□	3LSJBA	MX□	3LSZBA	MX□
	2400	1600	3LSFCF	MX□	3LSJCF	MX□	3LSZCF	MX□
	2000		3LSFCE	MX□	3LSJCE	MX□	3LSZCE	MX□
	1800		3LSFCD	MX□	3LSJCD	MX□	3LSZCD	MX□
	1600		3LSFCC	MX□	3LSJCC	MX□	3LSZCC	MX□
	1400		3LSFCB	MX□	3LSJCB	MX□	3LSZCB	MX□
	1200		3LSFCA	MX□	3LSJCA	MX□	3LSZCA	MX□

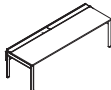
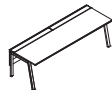
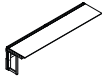
Line-up & Spec

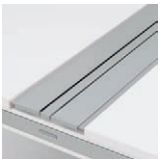
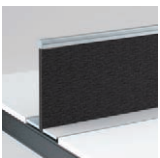
ONE-sided (Standard)			Free standing type				Joint type	
			Gate leg		Slant leg		Gate / Slant leg	
			Slim type					
								
Center option	W	D	Item number	Color	Item number	Color	Item number	Color
 <p>Center rail type</p>	2400	1400	3LTABF	MX□	3LTGBF	MX□	3LTXBF	MX□
	2000		3LTABE	MX□	3LTGBE	MX□	3LTXBE	MX□
	1800		3LTABD	MX□	3LTGBD	MX□	3LTXBD	MX□
	1600		3LTABC	MX□	3LTGBC	MX□	3LTXBC	MX□
	1400		3LTABB	MX□	3LTGBB	MX□	3LTXBB	MX□
	1200		3LTABA	MX□	3LTGBA	MX□	3LTXBA	MX□
	2400	1600	3LTACF	MX□	3LTGCF	MX□	3LTXCF	MX□
	2000		3LTACE	MX□	3LTGCE	MX□	3LTXCE	MX□
	1800		3LTACD	MX□	3LTGCD	MX□	3LTXCD	MX□
	1600		3LTACC	MX□	3LTGCC	MX□	3LTXCC	MX□
	1400		3LTACB	MX□	3LTGCB	MX□	3LTXCB	MX□
	1200		3LTACA	MX□	3LTGCA	MX□	3LTXCA	MX□
 <p>Center cover type</p>	2400	1400	3LTBBF	MX□	3LTHBF	MX□	3LTYBF	MX□
	2000		3LTBBE	MX□	3LTHBE	MX□	3LTYBE	MX□
	1800		3LTBBD	MX□	3LTHBD	MX□	3LTYBD	MX□
	1600		3LTBBC	MX□	3LTHBC	MX□	3LTYBC	MX□
	1400		3LTBBB	MX□	3LTHBB	MX□	3LTYBB	MX□
	1200		3LTBBA	MX□	3LTHBA	MX□	3LTYBA	MX□
	2400	1600	3LTBCF	MX□	3LTHCF	MX□	3LTYCF	MX□
	2000		3LTBCE	MX□	3LTHCE	MX□	3LTYCE	MX□
	1800		3LTBCD	MX□	3LTHCD	MX□	3LTYCD	MX□
	1600		3LTBCC	MX□	3LTHCC	MX□	3LTYCC	MX□
	1400		3LTBCB	MX□	3LTHCB	MX□	3LTYCB	MX□
	1200		3LTBCA	MX□	3LTHCA	MX□	3LTYCA	MX□
 <p>Desktop panel</p>	2400	1400	3LTFBF	MX□	3LTJBF	MX□	3LTZBF	MX□
	2000		3LTFBE	MX□	3LTJBE	MX□	3LTZBE	MX□
	1800		3LTFBD	MX□	3LTJBD	MX□	3LTZBD	MX□
	1600		3LTFBC	MX□	3LTJBC	MX□	3LTZBC	MX□
	1400		3LTFBB	MX□	3LTJBB	MX□	3LTZBB	MX□
	1200		3LTFBA	MX□	3LTJBA	MX□	3LTZBA	MX□
	2400	1600	3LTFCF	MX□	3LTJCF	MX□	3LTZCF	MX□
	2000		3LTFCE	MX□	3LTJCE	MX□	3LTZCE	MX□
	1800		3LTFCD	MX□	3LTJCD	MX□	3LTZCD	MX□
	1600		3LTFCC	MX□	3LTJCC	MX□	3LTZCC	MX□
	1400		3LTFCB	MX□	3LTJCB	MX□	3LTZCB	MX□
	1200		3LTFCA	MX□	3LTJCA	MX□	3LTZCA	MX□

Line-up & Spec | Standard

End options for multi-function leg

For Multi-function leg

Additional Storage Mount Type

TWO-sided

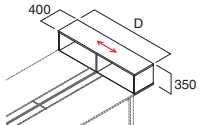

	D	H	Item number	Color
For bench / table type	1200	350	3L50AB	MX□□
	1400	350	3L50AD	MX□□
	1600	350	3L50AE	MX□□

For Multi-function leg

Additional Storage Mount Type

ONE-sided

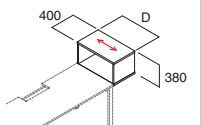

	D	H	Item number	Color
For free standing type	700	380	3L50BJ	MX□□
	800	380	3L50BK	MX□□
	1100	380	3L50BL	MX□□
	1200	380	3L50BM	MX□□

For Multi-function leg

Additional Storage Hanging Type

TWO-sided

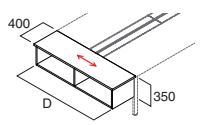

	D	H	Item number	Color
For bench / table type	1200	350	3L55AB	MX□□
	1400	350	3L55AD	MX□□
	1600	350	3L55AE	MX□□

For Multi-function leg

Additional Storage Hanging Type

ONE-sided

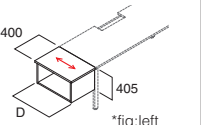

		D	H	Item number	Color
For free standing type	Left	700	405	3L55BJ	MX□□
		800	405	3L55BK	MX□□
		1100	405	3L55BL	MX□□
		1200	405	3L55BM	MX□□
	Right	700	405	3L56BJ	MX□□
		800	405	3L56BK	MX□□
		1100	405	3L56BL	MX□□
		1200	405	3L56BM	MX□□

For Multi-function leg

Additional Table

TWO-sided

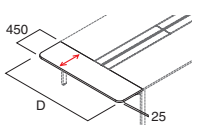

	W	D	Item number	Color
For bench / table type	450	1200	3L26AB	MX□□
	450	1400	3L26AD	MX□□
	450	1600	3L26AE	MX□□

For Multi-function leg

Additional Table

ONE-sided

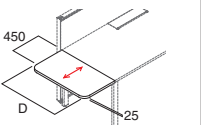

	W	D	Item number	Color
For free standing type	450	700	3L26CJ	MX□□
	450	800	3L26CK	MX□□
	450	1100	3L26CL	MX□□
	450	1200	3L26CM	MX□□

For Standard

Side Panels (End Panels) Slim Multi

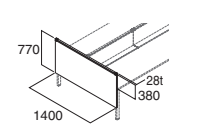

	D	H	Item number	Color
For bench / table type	1400	380	3L65GD	F□□□

For Standard

Side Panels (Center Alignment) Slim Multi

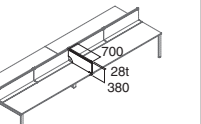

	D	H	Item number	Color
For bench type	700	380	3L444P	F□□□

Desktop panel

For Standard

Desktop Panel (Fabric)

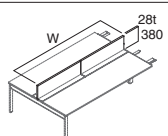

	W	H	Item number	Color
For bench type	2400	380	3L60GC	F□□□
	2000	380	3L60GD	F□□□
	1800	380	3L60GE	F□□□
	1600	380	3L60GF	F□□□
	1400	380	3L60GH	F□□□
	1200	380	3L60GK	F□□□

For Standard

Desktop Panel (Frost)

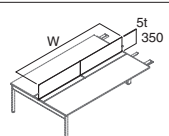

	W	H	Item number	Color
For bench type	2400	350	3L61GC	H219
	2000	350	3L61GD	H219
	1800	350	3L61GE	H219
	1600	350	3L61GF	H219
	1400	350	3L61GH	H219
	1200	350	3L61GK	H219

Line-up & Spec | Standard

Center rail options

For Standard				
Spot Panels (Fabric)				
	W	H	Item number	Color
For bench / table type Center rail only	800	380	3L60XZ	F□□□

For Standard				
Multipurpose Tray				
	W	D	Item number	Color
For bench / table type Center rail only	400	145	3L79ZA	Z25 Z637 ZA75

For Standard				
Spot Panels (Frost)				
	W	H	Item number	Color
For bench / table type Center rail only	800	380	3L61XZ	H219

For Standard			
Circle Tray			
	ø	Item number	Color
For bench / table type Center rail only	350	3L78ZA	MX□□

Option		
Hooks		
	Item number	Color
For 720H	3L880Y	T03

Option		
Cable guard		
	Item number	Color
	3L285Z	X300

Line up

[Bench type]



[Table type]



[Free standing type]



[Low partitioning workstation type]



[Conference table type]



Wagon position

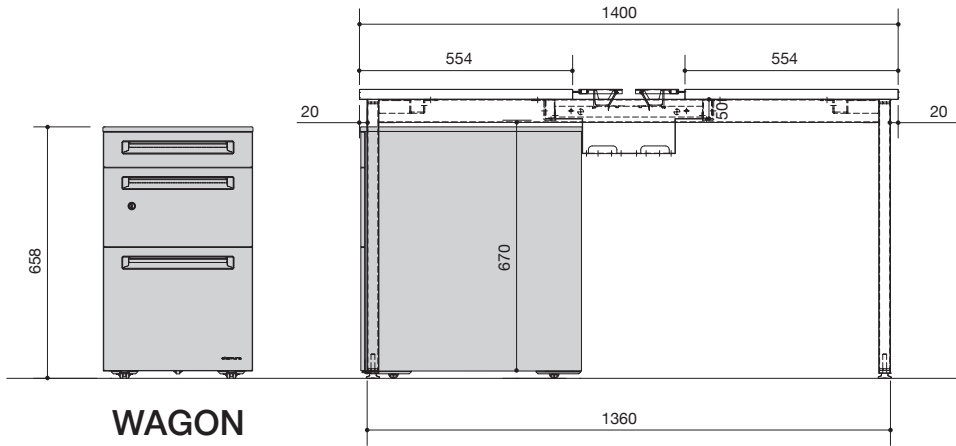

Wiring cover

Standard 1



Standard 2

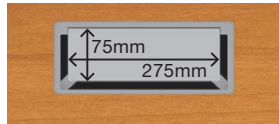

Box wiring

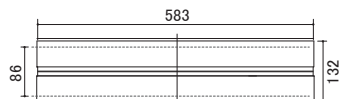
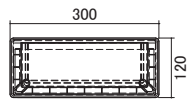
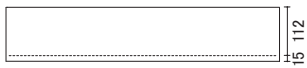
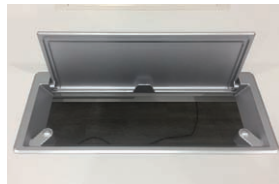
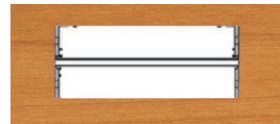

Color Collection

Surface Material Combination Code

Work Top



MX02 (Maple) MX03 (Cherry) MX04 (Moco Oak) MX05 (Modi Oak)



MX01 (White)

Leg



Z637 (Silver Metallic) ZA75 (Neo White) Z25 (Black)

Panel

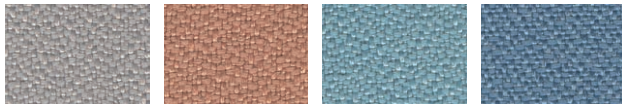

FMF1 (Gray) FMF2 (Desert) FMF3 (Aqua) FMF4 (Lagoon)

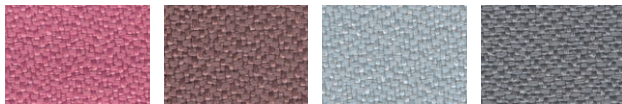

FMF5 (Cherry) FMF6 (Burgundy) FMF7 (Fossil) FMF8 (Graphite)

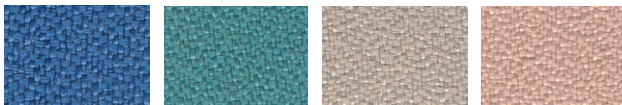

FMF9 (Marine) FMG1 (Emerald) FMG2 (Ivory) FMG3 (Sand)

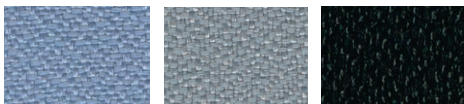

FMG4 (Sky) FMG5 (Ash) FMG7 (Black)

Combination Code	Color Code		
	Table Top	Edge	Beam Unit, Duct
MX21	MX01 White	CG01 White	Z637 Silver Metallic
MX22	MX02 Maple	CG02 Maple	
MX23	MX03 Cherry	CG03 Cherry	
MX24	MX04 Moco Oak	CG04 Moco Oak	
MX25	MX05 Modi Oak	CG05 Modi Oak	
MX31	MX01 White	CG01 White	ZA75 Neo White
MX32	MX02 Maple	CG02 Maple	
MX33	MX03 Cherry	CG03 Cherry	
MX34	MX04 Moco Oak	CG04 Moco Oak	
MX35	MX05 Modi Oak	CG05 Modi Oak	
MX41	MX01 White	CG01 White	Z25 Black
MX42	MX02 Maple	CG02 Maple	
MX43	MX03 Cherry	CG03 Cherry	
MX44	MX04 Moco Oak	CG04 Moco Oak	
MX45	MX05 Modi Oak	CG05 Modi Oak	

Combination Code	Color Code	
	Panel	Frame
FMH1	FMF1 Gray	Z637 Silver Metallic
FMH2	FMF2 Desert	
FMH3	FMF3 Aqua	
FMH4	FMF4 Lagoon	
FMH5	FMF5 Cherry	
FMH6	FMF6 Burgundy	
FMH7	FMF7 Fossil	
FMH8	FMF8 Graphite	
FMH9	FMF9 Marine	
FMJ1	FMG1 Emerald	
FMJ2	FMG2 Ivory	
FMJ3	FMG3 Sand	
FMJ4	FMG4 Sky	
FMJ5	FMG5 Ash	
FMJ7	FMG7 Black	
H219	H20 Frost	

Warranty Details

[Items covered under warranty]

This period assumes usage under normal office conditions (approximately 8 hours per day) starting from the date of purchase.

Exterior and surface finish	Discoloration or browning of painted and plastic parts, wear of leather	One year
Mechanical and movable parts	Malfunction of drawer sliding mechanism, door opening, locks, lifting/lowering mechanism, etc.	Two years
Structure	Damage related to strength and structure	Three years

* Okamura will repair product defects within the warranty period through product replacement, part replacement, etc.

* After the warranty period, repairs will incur a fee.

* The following will incur a fee, even within the warranty period.

- If no proof of purchase can be provided (purchase date, customer name, store name)
- Malfunctions or damage to the product resulting from use with disregard to the Okamura-issued owner's manual, posted product labels, etc.
- Malfunctions or damage of used parts, non-original parts, or individually purchased parts
- Consumable items (batteries, light bulbs, battery casters, leg tips and felt, armrest pads, etc.)
- Malfunctions or damage due to use or storage in a severe environment (high temperature, high humidity, significant changes in temperature, etc.)
- Difference in coloration, stitching, gloss, and other texture of natural materials (wood, leather, etc.)
- Malfunctions or damage caused by external factors outside the control of Okamura (natural disasters, fire, abnormal voltage, etc.)
- Alteration to the surface finish due to finger prints from use, dust, and other dirt
- Malfunctions or damage due to moving or transport after delivery
- Operational noise of movable parts (chair reclining, etc.)

Siam Okamura Steel Co.,Ltd.

Established 1988

Siam Okamura Steel Co., Ltd.

51/5 Poochao Rd. Bangyaparak, Samutprakarn

10310 Thailand Site Area:11,107 Sq.m.

PRODUCTION: Production facilities that create products conforming to and
FACILITIES & exceeding international standards is the structure supporting
LOGISTICS the Okamura Philosophy that “Quality pays for itself.”

JAPAN An integrated management system that controls product flow from production and distribution through sales and follow-up service has also added to the solid reputation and trust given to Siam Okamura Steel products.



OFFICES AND SHOWROOMS

Offices and subsidiaries

UK

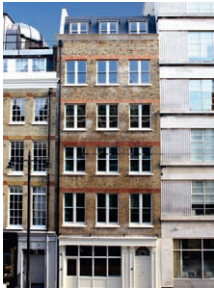

Okamura Corporation, London Branch

Location: 1st Floor, 54 Hatton Garden, London EC1N 8HN, UK
TEL: +44-20-3077-5930

THE NETHERLANDS



Okamura Corporation, Rotterdam Branch

Location: Stationsplein 45, Unit B7.043, 3013 AK Rotterdam, The Netherlands
TEL: +31-10-213-4414

CHINA



Shanghai Okamura Furniture and Logistics System Co., Ltd.

Location: 15F B block, FutureLand Building, No.5 Lane 388, Zhongjiang Road, Putuo District, Shanghai, 200062, China
TEL: +86-21-6074-6000

USA



Okamura Corporation, Chicago Branch

Location: 222 Merchandise Mart Plaza, Suite 11-124, Chicago, IL 60654, USA
TEL: +1-312-645-0115

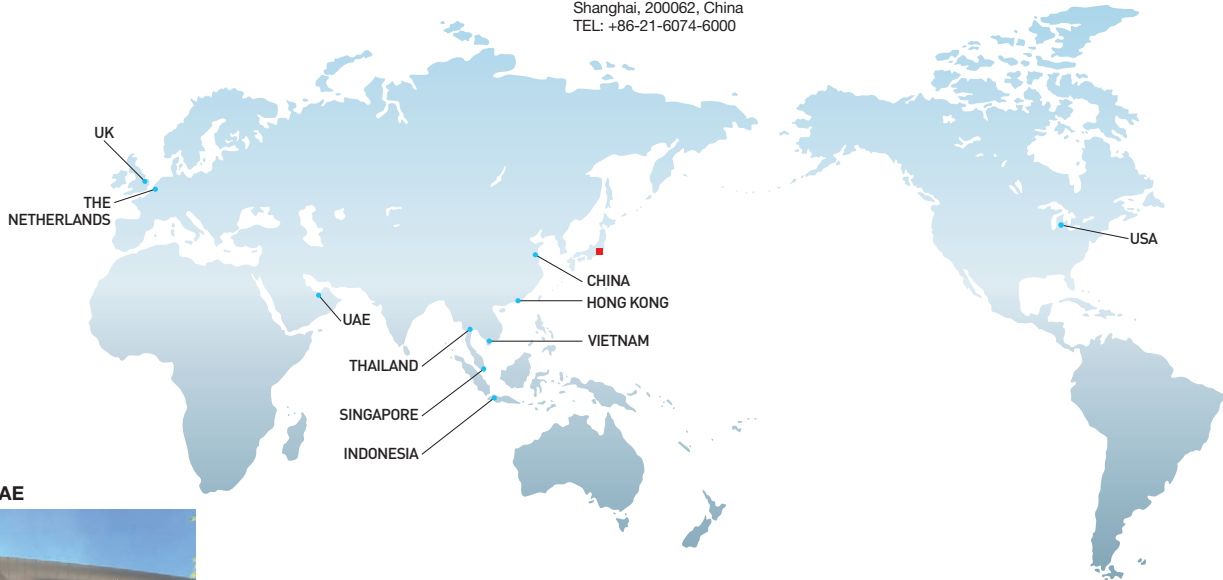

UAE



Okamura Corporation, Middle East (Branch)

Location: 6E-A, Room No. 521, Dubai Airport Free Zone, Dubai, UAE
TEL: +971-4-3575197

THAILAND



Siam Okamura International Co., Ltd.

Location: 3199 Maleenont Tower 19th Floor, Rama 4 Road, Klongton, Klongtoey, Bangkok 10110, Thailand
TEL: +66-2661-5474

SINGAPORE



Okamura International (Singapore) Pte Ltd

Location: 16 Raffles Quay #14-02 Hong Leong Building, Singapore 048581
TEL: +65-6224-7995

INDONESIA



PT. Okamura Chitose Indonesia

Location: MidPlaza-2 12th Floor, Jl.Jend. Sudirman Kav 10-11, Jakarta 10220, Indonesia
TEL: +62-21-572-3925

VIETNAM



Okamura Corporation, Ho Chi Minh Representative Office

Location: Suite 1104 11th Floor Saigon Tower, 29 Le Duan St., District 1, HCMC, Vietnam
TEL: +84-8-3822-6392

HONG KONG



Salotto (China) Limited

Location: 2903 Two Chinachem Exchange Square, 338 King's Road, North Point, Hong Kong
TEL: +852-2898-9777

Showrooms



TOKYO

GARDEN COURT SHOWROOM
 Location : Hotel New Otani, 3rd Floor,
 Garden-Court, 4-1 Kioi-cho,
 Chiyoda-ku, Tokyo, Japan
 Telephone : +81-3-5276-2001

Okamura Chair Museum
 Location : 2-13-2, Nagata-cho,
 Chiyoda-ku, Tokyo, Japan
 Telephone : +81-3-3593-6195



CHICAGO

Location : 222 Merchandise
 Mart Plaza, Suite 11-124,
 Chicago, IL 60654, U.S.A.
 Telephone : +1-312-645-0115



SHANGHAI

Xintiandi Showroom
 Location : Room 08-15 18F
 3 Corporate Avenue, 168 Hubin Road,
 Shanghai China
 Telephone : +86-21-6333-9080



BANGKOK

Location : 3199 Maleenont Tower
 19th Floor, Rama4 Road, Klongton,
 Klongtoey, Bangkok 10110, Thailand
 Telephone : +66-2661-5474



SINGAPORE

Location : 16 Raffles Quay #14-02,
 Hong Leong Building,
 Singapore 048581
 Telephone : +65-6224-7995



HONG KONG

Location : 2903 Two Chinachem
 Exchange Square, 338
 King's Road, North Point,
 Hong Kong
 Telephone : +852-2898-9777

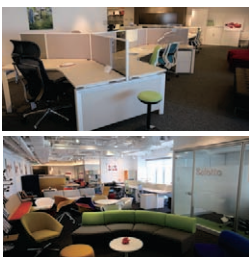

JAKARTA

Location : MidPlaza-2 12th Floor,
 Jl. Jend. Sudirman Kav 10-11,
 Jakarta 10220, Indonesia
 Telephone : +62-21-572-3925



M : Metro (Subway)

