

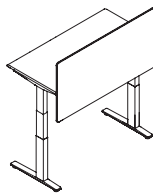

Statement of Line

Work table | P2-10

Free standing type → P4

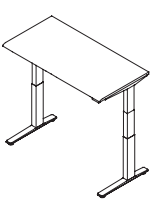

With front screen

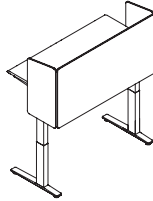

With front and side screens

L-shaped type → P5

*Only the table top with a knife edge available.

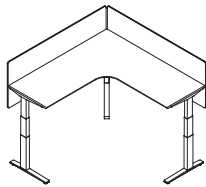
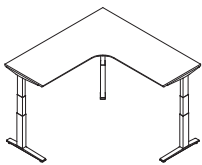

With front screen

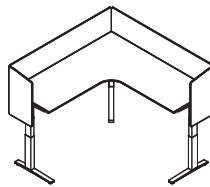

With front and side screens

Bench type → P6

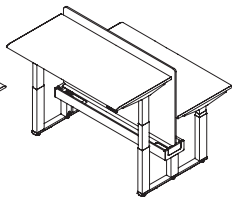
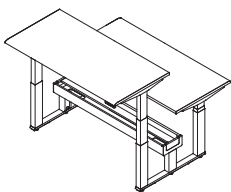

With fixed screen

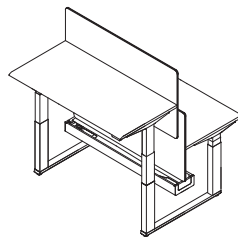

With individual screens

Conference table | P11-12

2-column table

Wide: 82 3/4", 94 1/2"

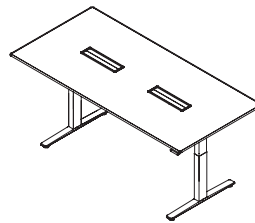

With cable opening

Wide: 70 7/8"

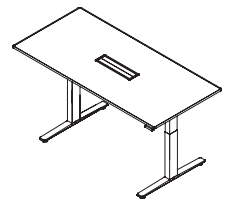

Wide: 82 3/4", 94 1/2"

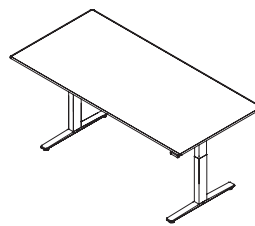

Without cable opening

Wide: 70 7/8"

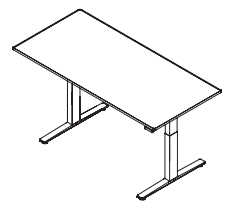

4-column table - wide type

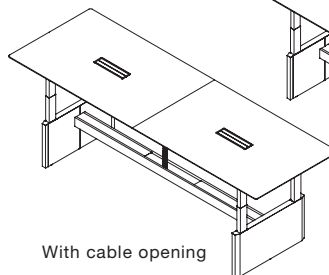

With cable opening

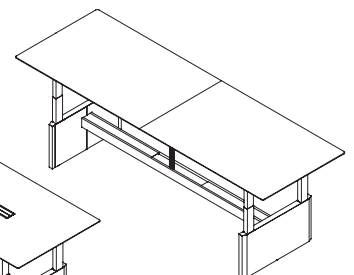

Without cable opening

Basic Table Specifications

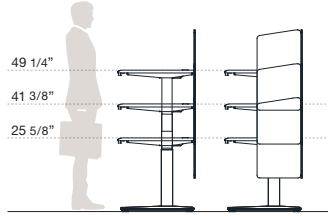

You can adjust the table top height within the range from 25 5/8" to 49 1/4".

*With a safety reverse function that moves the desk approximately 1inch backward (approximately 1 1/8" when the desk is moved slowly) immediately when the desk hits an obstacle as standard
 *Rated voltage: 100V, rated frequency: 50/60Hz
 *Rated power consumption: free standing type: 300W L-shaped type: 450W bench type: 600W

When laying out tables, be sure to leave the amount of space indicated below between them to ensure safety.

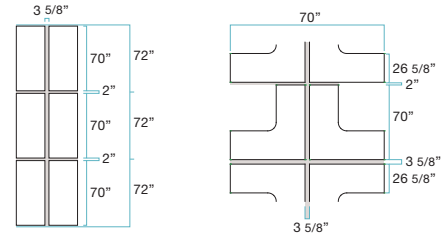

Free standing type
Bench type

L-shaped type

Customizable Type

■ Control panel



You can choose between three different types: the "button type (with the indicator)" including a height display and a memory function which allows you to save your preferred height, the simpler "button type (without the indicator)" which only includes a lifting and lowering button, and the "lever type" which allows you to lift or lower the desk more intuitively.

■ Table top edge



A sloped edge with a smooth, round surface that remains comfortable even if you lean on it with your arms. You can also select a more linear and sharper knife edge.

Color

■ Leg color



■ Table top color

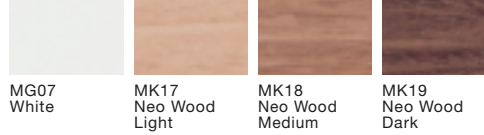

Desk combination code

Combination code	Part name / code		Combination code	Part name / code		Combination code	Part name / code	
	Table top	Body		Table top	Body		Table top	Body
MY31 (White)	MG99	MG07 (Melamine: White)	MY21 (White)	MG99	MG07 (Melamine: White)	MY11 (White)	MG99	MG07 (Melamine: White)
		G939 (Edge: White)			G939 (Edge: White)			G939 (Edge: White)
MY32 (Neo Wood Light)	MK37	MK17 (Melamine: Neo Wood Light)	MY22 (Neo Wood Light)	MK37	MK17 (Melamine: Neo Wood Light)	MY12 (Neo Wood Light)	MK37	MK17 (Melamine: Neo Wood Light)
		G947 (Edge: Neo Wood Light)			G947 (Edge: Neo Wood Light)			G947 (Edge: Neo Wood Light)
MY33 (Neo Wood Medium)	MK38	MK18 (Melamine: Neo Wood Medium)	MY23 (Neo Wood Medium)	MK38	MK18 (Melamine: Neo Wood Medium)	MY13 (Neo Wood Medium)	MK38	MK18 (Melamine: Neo Wood Medium)
		G948 (Edge: Neo Wood Medium)			G948 (Edge: Neo Wood Medium)			G948 (Edge: Neo Wood Medium)
MY34 (Neo Wood Dark)	MK39	MK19 (Melamine: Neo Wood Dark)	MY24 (Neo Wood Dark)	MK39	MK19 (Melamine: Neo Wood Dark)	MY14 (Neo Wood Dark)	MK39	MK19 (Melamine: Neo Wood Dark)
		G949 (Edge: Neo Wood Dark)			G949 (Edge: Neo Wood Dark)			G949 (Edge: Neo Wood Dark)

■ Screen color

Free standing type, L-shaped type Front and side screens (unicolor screen)



Free standing type, L-shaped type Front and side screens, two-tone cloth combination color *Front and side screens only

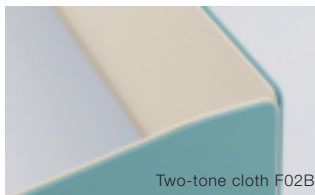

Combination code	Cloth / outside	Cloth / inside
F02B	F002 (Sage)	 F024 Vanilla
F07B	F007 (Huckleberry)	
F10B	F010 (Pumpkin)	
F13B	F013 (Blackberry)	
F15B	F015 (Grape)	
F25B	F025 (Mushroom)	
F27B	F027 (Chamomile)	
F29B	F029 (Indigo)	

Bench type Fixed screen Color combination code

Combination code	Cloth	Body	Combination code	Cloth	Body	Combination code	Cloth	Body
FZT1	F002 (Sage)	ZF97 (White)	FZS1	F002 (Sage)	ZF96 (Silver)	FZR1	F002 (Sage)	ZF95 (Black)
FZT2	F007 (Huckleberry)		FZS2	F007 (Huckleberry)		FZR2	F007 (Huckleberry)	
FZT3	F010 (Pumpkin)		FZS3	F010 (Pumpkin)		FZR3	F010 (Pumpkin)	
FZT4	F013 (Blackberry)		FZS4	F013 (Blackberry)		FZR4	F013 (Blackberry)	
FZT5	F015 (Grape)		FZS5	F015 (Grape)		FZR5	F015 (Grape)	
FZT6	F025 (Mushroom)		FZS6	F025 (Mushroom)		FZR6	F025 (Mushroom)	
FZT7	F027 (Chamomile)		FZS7	F027 (Chamomile)		FZR7	F027 (Chamomile)	
FZT8	F029 (Indigo)		FZS8	F029 (Indigo)		FZR8	F029 (Indigo)	

Free Standing Type

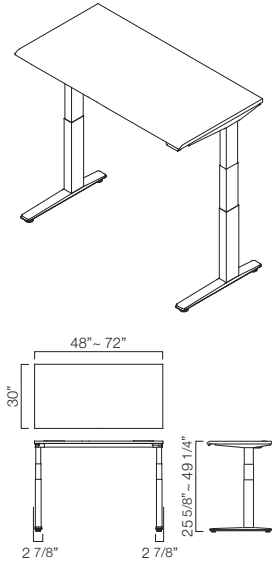

*Rated power consumption: 300W

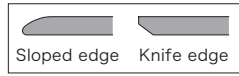

Table

Control panel	W	D	H	Sloped edge	Knife edge	
				Item code	Item code	
Button type 	with indicator	30"	49 1/4" ± 25 5/8"	72"	3W20AA-MY□□	3W20FA-MY□□
				66"	3W20AB-MY□□	3W20FB-MY□□
				60"	3W20AC-MY□□	3W20FC-MY□□
				54"	3W20AD-MY□□	3W20FD-MY□□
	without indicator	30"	49 1/4" ± 25 5/8"	48"	3W20AE-MY□□	3W20FE-MY□□
				72"	3W20BA-MY□□	3W20GA-MY□□
				66"	3W20BB-MY□□	3W20GB-MY□□
				60"	3W20BC-MY□□	3W20GC-MY□□
Lever type 	without indicator	30"	49 1/4" ± 25 5/8"	54"	3W20BD-MY□□	3W20GD-MY□□
				48"	3W20BE-MY□□	3W20GE-MY□□
				72"	3W20BF-MY□□	3W20GF-MY□□
				66"	3W20BG-MY□□	3W20GG-MY□□
	with indicator	30"	49 1/4" ± 25 5/8"	60"	3W20BH-MY□□	3W20GH-MY□□
				54"	3W20BJ-MY□□	3W20GJ-MY□□
				48"	3W20BK-MY□□	3W20GK-MY□□
				72"		

Screen (optional)

	Front			Front and sides				
Type	W	H	T	Item code	W	H	T	Item code
17 3/4" Top surface	70"	31 7/8"	0.6"	3W61AA-F□□□	70"	31 7/8"	0.6"	3W60AA-F□□□
	64"			3W61AB-F□□□	64"			3W60AB-F□□□
	58"			3W61AC-F□□□	58"			3W60AC-F□□□
	52"			3W61AD-F□□□	52"			3W60AD-F□□□
	46"			3W61AE-F□□□	46"			3W60AE-F□□□
13 3/4" Top surface	70"	28"	0.6"	3W61BA-F□□□	70"	28"	0.6"	3W60BA-F□□□
	64"			3W61BB-F□□□	64"			3W60BB-F□□□
	58"			3W61BC-F□□□	58"			3W60BC-F□□□
	52"			3W61BD-F□□□	52"			3W60BD-F□□□
	46"			3W61BE-F□□□	46"			3W60BE-F□□□

Clamp-free zone dimensions

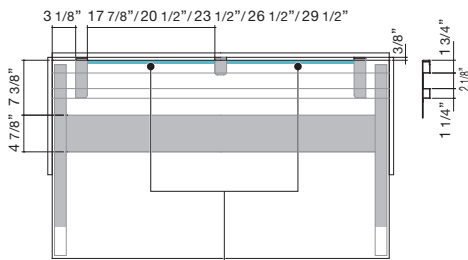

Area where clamping is possible with screen.

Required items and options

Item	Required / Option	Notes
Table	Required	
Screen	Option	Select according to the type of desk.
Cable guard	Option	Select single or double according to the cable capacitance.
Cable tray	Option	Select according to the type of desk.
Opposite table connector	Required depending on the conditions	Required when using an opposing layout.
Desktop power unit	Option	
Pedestal	Option	

L-shaped Type

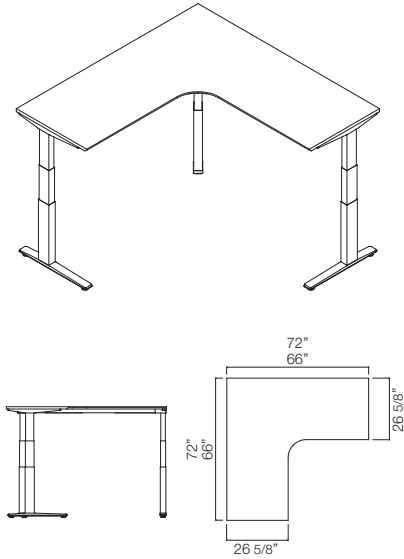

*Rated power consumption: 450W

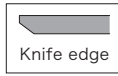

■ Table

Control panel		W	D	H	Item code
Button type	with indicator 	72"×72"	26 5/8"	49 1/4" 25 5/8"	3W23PJ-MY <input type="checkbox"/>
		66"×66"			3W23PK-MY <input type="checkbox"/>
	without indicator 	72"×72"			3W23PL-MY <input type="checkbox"/>
		66"×66"			3W23PM-MY <input type="checkbox"/>
Lever type	without indicator 	72"×72"	3W23PS-MY <input type="checkbox"/>		
		66"×66"	3W23PT-MY <input type="checkbox"/>		

■ Screen (optional)

		Front			Front and sides			
Type	W	H	T	Item code	W	H	T	Item code
17 3/4" Top surface	72"	31 7/8"	0.6"	3W61PJ-F <input type="checkbox"/>	72"	31 7/8"	0.6"	3W60PJ-F <input type="checkbox"/>
	66"			3W61PK-F <input type="checkbox"/>	66"			3W60PK-F <input type="checkbox"/>
13 3/4" Top surface	72"	28"	0.6"	3W61PL-F <input type="checkbox"/>	72"	28"	0.6"	3W60PL-F <input type="checkbox"/>
	66"			3W61PM-F <input type="checkbox"/>	66"			3W60PM-F <input type="checkbox"/>

■ Required items and options

Item	Required / Option	Notes
Table	Required	
Screen	Option	Select according to the type of desk.
Cable guard	Option	Select single or double according to the cable capacitance.
Cable tray	Option	Select according to the type of desk.
Opposite table connector	Required depending on the conditions	Required when using an opposing layout.
Desktop power unit	Option	
Pedestal	Option	

Bench Type

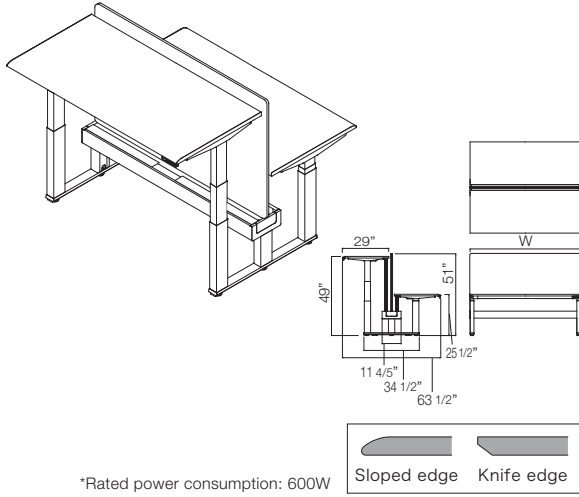

*Rated power consumption: 600W

Table

Control panel	W	D	H	Sloped edge	Knife edge	
				Item code	Item code	
Button type 	with indicator 	72"	61 1/2"	49 1/4" / 25 5/8"	3W22AA-MY□□	3W22FA-MY□□
		66"			3W22AB-MY□□	3W22FB-MY□□
		60"			3W22AC-MY□□	3W22FC-MY□□
		54"			3W22AD-MY□□	3W22FD-MY□□
	without indicator 	72"	61 1/2"	49 1/4" / 25 5/8"	3W22AE-MY□□	3W22FE-MY□□
		66"			3W22BA-MY□□	3W22GA-MY□□
		60"			3W22BB-MY□□	3W22GB-MY□□
		54"			3W22BC-MY□□	3W22GC-MY□□
Lever type 	without indicator 	72"	61 1/2"	49 1/4" / 25 5/8"	3W22BD-MY□□	3W22GD-MY□□
		66"			3W22BE-MY□□	3W22GE-MY□□
		60"			3W22BF-MY□□	3W22GF-MY□□
		54"			3W22BG-MY□□	3W22GG-MY□□
	with indicator 	72"	61 1/2"	49 1/4" / 25 5/8"	3W22BH-MY□□	3W22GH-MY□□
		66"			3W22BJ-MY□□	3W22GJ-MY□□
		60"			3W22BK-MY□□	3W22GK-MY□□
		54"				

*With special cable guides (two pieces) *Be sure to use a center panel for the desktop panel.

Fixed screen (optional)

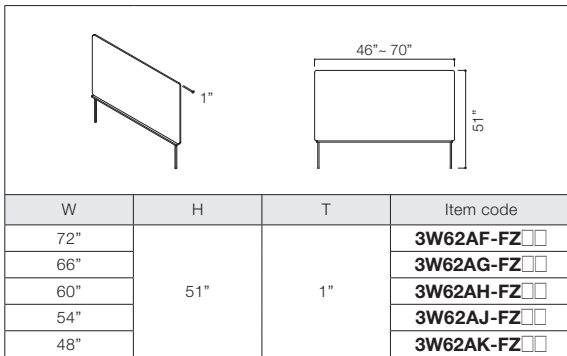

Individual screen (optional)

Type	Front				Front and sides			
	W	H	T	Item code	W	H	T	Item code
17 3/4" Top surface	70"	31 7/8"	0.6"	3W61GA-F□□□	70"	31 7/8"	0.6"	3W60GA-F□□□
	64"			3W61GB-F□□□	64"			3W60GB-F□□□
	58"			3W61GC-F□□□	58"			3W60GC-F□□□
	52"			3W61GD-F□□□	52"			3W60GD-F□□□
	46"			3W61GE-F□□□	46"			3W60GE-F□□□
13 3/4" Top surface	70"	28"	0.6"	3W61HA-F□□□	70"	28"	0.6"	3W60HA-F□□□
	64"			3W61HB-F□□□	64"			3W60HB-F□□□
	58"			3W61HC-F□□□	58"			3W60HC-F□□□
	52"			3W61HD-F□□□	52"			3W60HD-F□□□
	46"			3W61HE-F□□□	46"			3W60HE-F□□□

*Front panel and center panel cannot be used together.

End cover (optional)

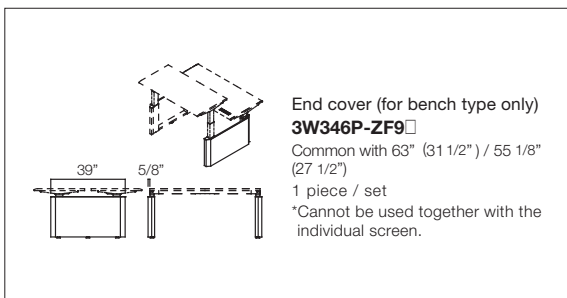

Required items and options

Item	Required / Option	Notes
Table	Required	
Screen	Option	Select according to the type of table. Only one can be selected.
End cover	Option	
Power source cable : Module kit	Required	Select one set for each desk according to the type of table.
Power source cablelet : Receptacle	Required	Select a total of four for each desk according to the electrical circuit.
Power source cable : Power infeed	Required	Select one each according to the length of the required cable (from the floor to the starting position).
Wiring duct cover	Required	Select according to use of a center panel and type of desk.
Cable tray	Option	Select according to the type of desk.
Desktop power unit	Option	
Pedestal	Option	

●The dimensions are indicated in inch.

Power Source Cable

(1) Module kit for each width

W	Item code
For 72"	3P51AA-Y647
For 66"	3P51AB-Y647
For 60"	3P51AC-Y647
For 54"	3P51AD-Y647
For 48"	3P51AE-Y647

*Select according to the table width.
*Order one set for each table set.

(2) Receptacle

Circuit	Item code
1	3P11UP-Y708
2	3P11VP-Y708
3	3P11WP-Y708
4	3P11XP-Y708

*Y708 (Black)
*Order 4 receptacles for each module kit.

(3) Hardwire power infeed

W	Item code
240"	3P11LP-Y647
120"	3P11MP-Y647
72"	3P11NP-Y647

(4) Wiring duct cover

For use without fixed screen		For use with fixed screen	
W	Item code	W	Item code
For 72"	3W7A0Y-ZF9	For 72"	3W7A5Y-ZF9
For 66"	3W7A1Y-ZF9	For 66"	3W7A6Y-ZF9
For 60"	3W7A2Y-ZF9	For 60"	3W7A7Y-ZF9
For 54"	3W7A3Y-ZF9	For 54"	3W7A8Y-ZF9
For 48"	3W7A4Y-ZF9	For 48"	3W7A9Y-ZF9

*ZF97 (White), ZF96 (Silver), ZF95 (Black)

Electrical Diagram

- Utilizes 8-wire, 4-circuit electrical module system as power source for each outlet in wiring duct.
- For every power infeed of 4-circuit electrical module system a 3 + 1 configuration is available as standard.
- All electrical module systems need to be installed in field with the back-to-back height adjustable table by furniture installer.
- 20-amp hardwire power infeed only. A licensed electrician is required to complete hardwire connections to building's power source.
- Hardwire power infeed is having 3 length(72"/120"/240") as standard. Other length hardwire power infeed is available as an option.
- Hardwire power infeed is flexible metal conduit as standard. Liquid-tight conduit option available.
- Neutral(White) wires are 10 gauge, hot and ground wires are 12 gauge
- When specify, receptacles must be specified separately.
- Power source cables and desktop power outlets are UL listed for upholding strict safety standards.

Chicago Electrical Requirements

The city of Chicago may require hardwiring of electrical components. For Chicago applications, please contact your local representatives or dealerships.

Other Municipality Electrical Requirements

Other metropolitan areas besides Chicago may have special electrical requirements as well. Consult a local electrical contractor for proper code compliance information.

Electrical diagram for Hardwire Power infeed.

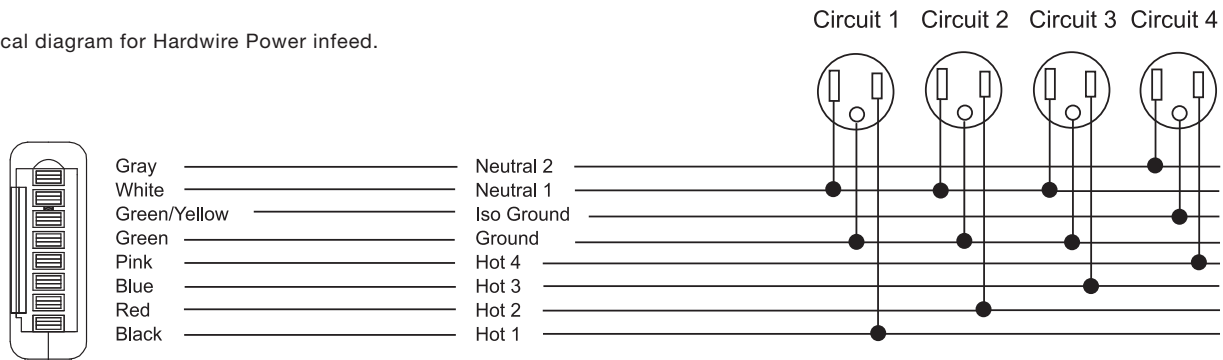

●The dimensions are indicated in inch.

Cable Routing Diagram

Required cable length from outlet to center of tabletop: 47 1/4" (recommended)

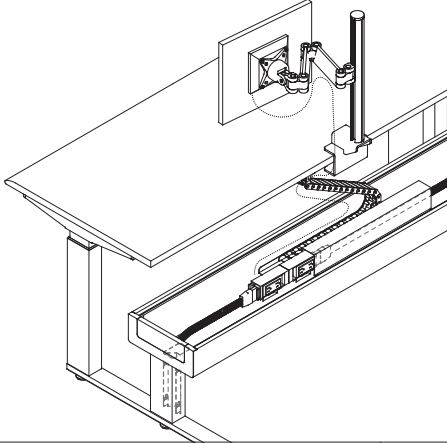

Wiring Duct Joint Part Dimensions

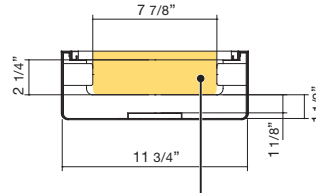

Cable passes through this section

Cable Guard Dimensions

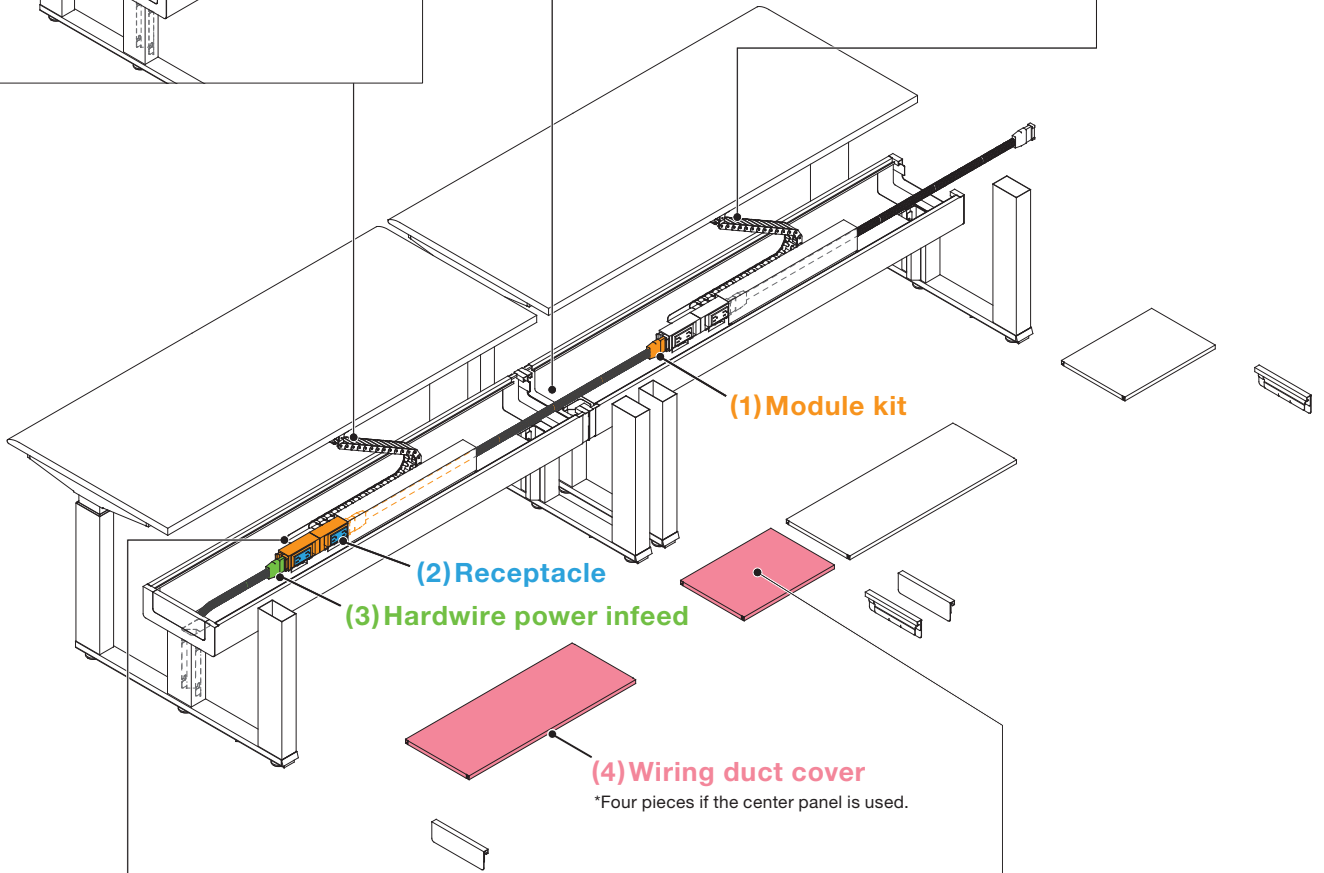
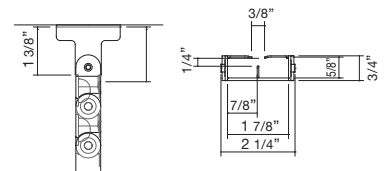

Wiring Duct Dimensions

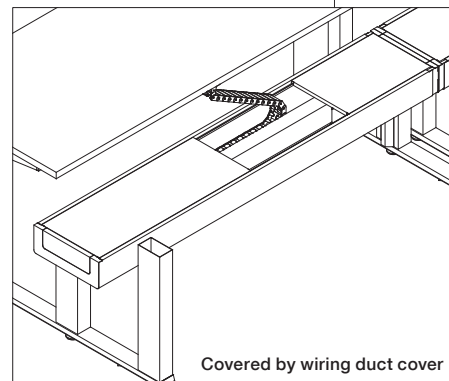
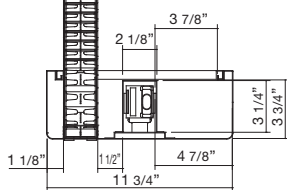

*Four pieces if the center panel is used.

●The dimensions are indicated in inch.

Effective Dimensions From The Leg To The Duct

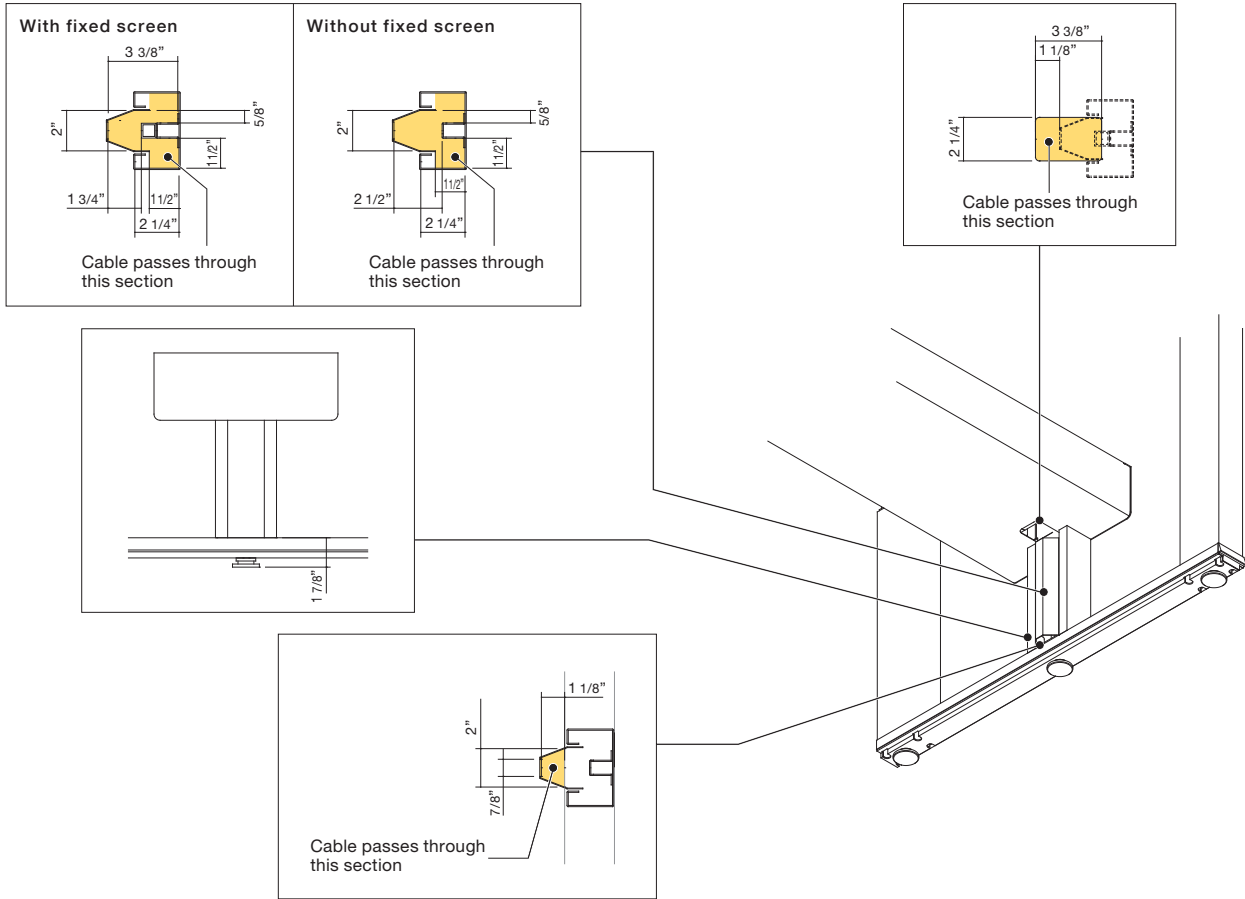

Power Infeed Floor Entry Location

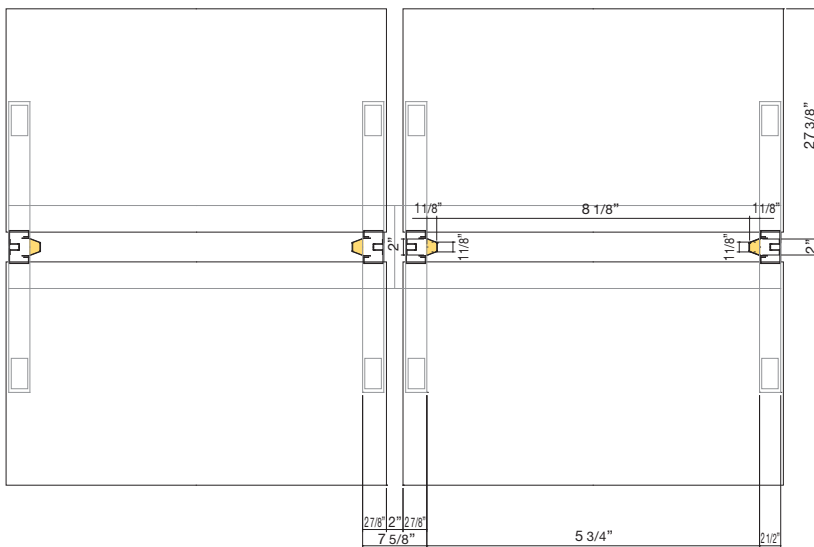

Clamp-free Zone Dimensions

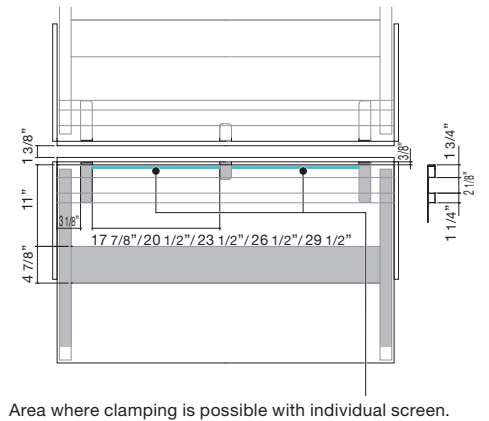

●The dimensions are indicated in inch.

Options

■ Cable guard (Free standing type / L-shaped type)

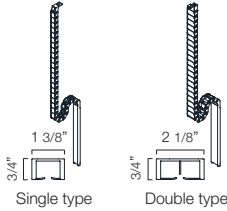

Single duct type cable guard

3W641Y-ZF□□

Double duct type cable guard

3W646Y-ZF□□

ZF95 (Black)

ZF96 (Silver)

ZF97 (White)

*Prepare a cable with a length of 59".

■ Cable tray (large-capacity type)

Type	W	Item code
For free standing type, bench type	For 72"	3W6D5P-G473
	For 66"	3W6D6P-G473
	For 60"	3W6D7P-G473
	For 54"	3W6D8P-G473
For L-shaped type	For 72"	3W6K5P-G473
	For 66"	3W6K7P-G473

1 piece / set G473 (Black)

*Replace the cable tray included in the desk (standard type) with this tray. This tray cannot be used together with the standard type.

*The lowest height of the desk table top when the special SW wagon is used is 26 3/4".

■ Opposite table connector



For Free standing and L-shaped types

3W971Y-G□□□

2 pieces / set

When laying out desks opposite each other, attach these couplings to the end legs. Please order enough couplings for the number of end legs you wish to connect.

G975 (Neo White)

G204 (Black)

G636 (Skip Gray)

■ Desktop power unit



Power×3

3P13AY-Y707

Cable length:120"

Y707 (White)



Power×2, USB×2

3P13BY-Y707

Cable length:120"

Y707 (White)

■ Pedestal



Pedestal side handgrip

3W33AA-Z□□□

15 3/8"W×22 7/8"D×22 1/8"H

Inside dimensions: Upper Pen tray drawer 12 1/2"W×17 5/8"D×1 5/8"H, Center Ordinary drawer 12 1/2"W×17 1/4"D×7"H, Lower filing drawer (A4 size) 12 1/2"W×20 1/2"D×10 3/8"H



Pedestal front handgrip

3WC3AA-Z□□□

15 3/8"W×22 7/8"D×22 1/8"H



Pedestal with a drawer + a pen tray

3W31BZ-Z□□□

15 3/8"W×22 7/8"D×15 3/4"H

With two partition plates and a latch (filing drawer), an all-locking key (with lock / release display), caster stoppers, rollers for overturning prevention



Stool pedestal

With a drawer + a pen tray, side handgrip

3W31BX-Z□□□

15 1/2"W×22 7/8"D×17 3/8"H

With two partition plates, a latch (filing drawer), an all-locking key (with lock / release display), caster stoppers, rollers for overturning prevention, a pen tray drawer (inside dimensions: 12 1/2"W×17 5/8"D×1 5/8"H), a B4/A4 filing drawer (inside dimensions: 12 1/2"W×20 1/2"D×11 1/2"H)

Common specifications: An all-locking key (with lock / release display), caster stoppers, rollers for overturning prevention, a latch. Each filing drawer or ordinary drawer has one partition plate.

Common colors: Z25 (Black), Z637 (Skip Silver), Z975 (Neo White)

Basic Table Specifications

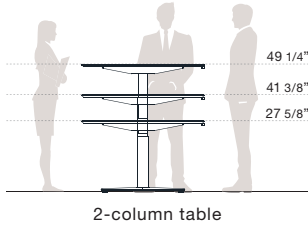

2-column table

The tabletop height of the meeting table can be adjusted within the range from 27 5/8" to 49 1/4".

*With a safety reverse function that moves the desk approximately 1inch backward (approximately 1 1/8" when the desk is moved slowly) immediately when the desk hits an obstacle as standard
*Rated voltage 100 V, rated frequency 50/60Hz
*Rated power consumption: 300W

Basic Table Specifications (wide type)

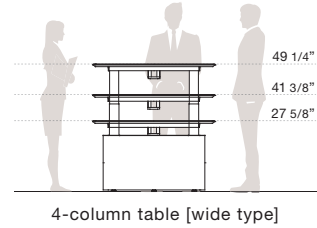

4-column table [wide type]

The tabletop height of the meeting table (wide type) can be adjusted within the range from 27 5/8" to 49 1/4".

*With a safety reverse function that moves the desk approximately 1inch backward (approximately 1 1/8" when the desk is moved slowly) immediately when the desk hits an obstacle as standard
*Rated voltage 100 V, rated frequency 50/60 Hz
*Rated power consumption: 600W

Control panel

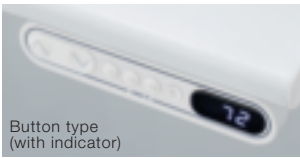

Button type (with indicator)

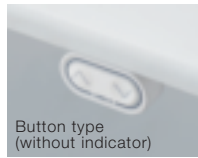

Button type (without indicator)

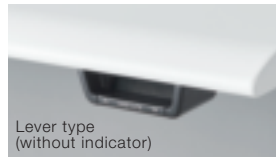

Lever type (without indicator)

You can choose between three different types: the "button type (with the indicator)" including a height display and a memory function which allows you to save your preferred height, the simpler "button type (without the indicator)" which only includes a lifting and lowering button, and the "lever type" which allows you to lift or lower the desk more intuitively.

Four tabletop colors



The entire circumference is equally curved. The molded resin structure gives the surface a soft feel.

Cable opening



The cable cover can be opened and closed. A spacious opening allows you to store power strips and similar equipment inside. When not using the cable duct, use the cover to close it completely.

Color

*Common with the wide type

Leg color



ZF97 White

ZF96 Silver

ZF95 Black

Table top color



MY01 White

MG07 White

MK17 Neo Wood Light

MK18 Neo Wood Medium

MK19 Neo Wood Dark

Table combination code

Combination code	Part name / code		Combination code	Part name / code		Combination code	Part name / code	
	Table top	Body		Table top	Body		Table top	Body
MY30 (White)	MY01	MG07 (Melamine: White)	MY20 (White)	MY01	MG07 (Melamine: White)	MY10 (White)	MY01	MG07 (Melamine: White)
		GC70 (Edge: Pale Gray)			GC70 (Edge: Pale Gray)			GC70 (Edge: Pale Gray)
MY32 (Neo Wood Light)	MK37	MK17 (Melamine: Neo Wood Light)	MY22 (Neo Wood Light)	MK37	MK17 (Melamine: Neo Wood Light)	MY12 (Neo Wood Light)	MK37	MK17 (Melamine: Neo Wood Light)
		G947 (Edge: Neo Wood Light)			G947 (Edge: Neo Wood Light)			G947 (Edge: Neo Wood Light)
MY33 (Neo Wood Medium)	MK38	MK18 (Melamine: Neo Wood Medium)	MY23 (Neo Wood Medium)	MK38	MK18 (Melamine: Neo Wood Medium)	MY13 (Neo Wood Medium)	MK38	MK18 (Melamine: Neo Wood Medium)
		G948 (Edge: Neo Wood Medium)			G948 (Edge: Neo Wood Medium)			G948 (Edge: Neo Wood Medium)
MY34 (Neo Wood Dark)	MK39	MK19 (Melamine: Neo Wood Dark)	MY24 (Neo Wood Dark)	MK39	MK19 (Melamine: Neo Wood Dark)	MY14 (Neo Wood Dark)	MK39	MK19 (Melamine: Neo Wood Dark)
		G949 (Edge: Neo Wood Dark)			G949 (Edge: Neo Wood Dark)			G949 (Edge: Neo Wood Dark)

●The dimensions are indicated in inch.

2-column Table

With cable opening

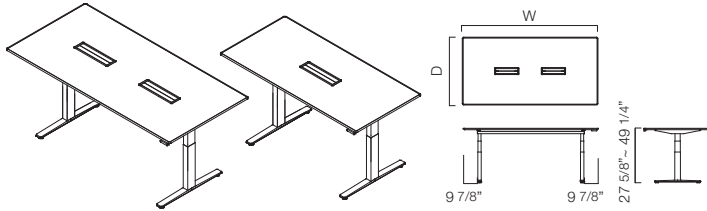

*The 94 1/2" and 82 3/4" models have two cable openings, and the 70 7/8" model has one cable opening.

Without cable opening

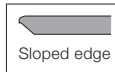
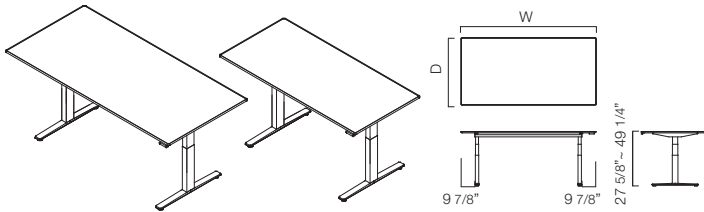

*Rated power consumption: 300W

Cable opening	Control panel	W	D	H	Item code	
Yes	Button type 	with indicator	94 1/2"	47 1/4"	49 1/4" 27 5/8"	3W27AA-MY □□
			82 3/4"	43 3/8"		3W27AB-MY □□
			70 7/8"	35 1/2"		3W27AC-MY □□
	Button type 	without indicator	94 1/2"	47 1/4"		3W27BB-MY □□
			82 3/4"	43 3/8"		3W27BC-MY □□
			70 7/8"	35 1/2"		3W27BD-MY □□
Lever type 	without indicator	94 1/2"	47 1/4"	3W27BE-MY □□		
		82 3/4"	43 3/8"	3W27BF-MY □□		
		70 7/8"	35 1/2"	3W27BG-MY □□		
No	Button type 	with indicator	94 1/2"	47 1/4"		3W27CA-MY □□
			82 3/4"	43 3/8"		3W27CB-MY □□
			70 7/8"	35 1/2"		3W27CC-MY □□
	Button type 	without indicator	94 1/2"	47 1/4"	3W27EB-MY □□	
			82 3/4"	43 3/8"	3W27EC-MY □□	
			70 7/8"	35 1/2"	3W27ED-MY □□	
Lever type 	without indicator	94 1/2"	47 1/4"	3W27EE-MY □□		
		82 3/4"	43 3/8"	3W27EF-MY □□		
		70 7/8"	35 1/2"	3W27EG-MY □□		

Option

■ **Vertical cable guard**



3W288Z-G764

G764 (Clear)

*Use a vertical cable guard to prevent the power cord from breaking.

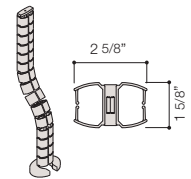

■ **Required items and options**

Item	Required / Option
Table	Required
Vertical cable guard	Option

4-column Table (wide type)

With cable opening

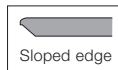
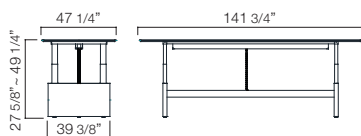
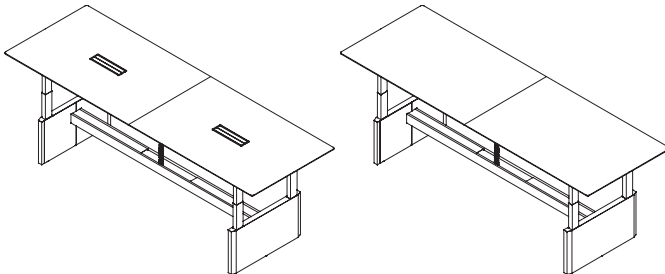

*Rated power consumption: 600W

Cable opening	Control panel	W	D	H	Item code			
Yes	Button type 	with indicator	141 3/4"	47 1/4"	49 1/4" 27 5/8"	3W27KA-MY □□		
			118 1/8"			3W27KB-MY □□		
		without indicator	141 3/4"			3W27LA-MY □□		
	Button type 	without indicator	141 3/4"			3W27LB-MY □□		
			118 1/8"			3W27LF-MY □□		
			118 1/8"			3W27LH-MY □□		
No	Button type 	with indicator	141 3/4"			47 1/4"	49 1/4" 27 5/8"	3W27KD-MY □□
			118 1/8"					3W27KE-MY □□
		without indicator	141 3/4"					3W27LD-MY □□
	Button type 	without indicator	141 3/4"					3W27LE-MY □□
			118 1/8"					3W27LK-MY □□
			118 1/8"					3W27LL-MY □□

*With integrated cable guides