

LW

Spec Guide

Issued August 2021

[BIFMA (inch) Standard]



LW Chair

Body and Leg types



Body	White	White	Black	Black
Leg	Polished	White	Polished	Black



Body	White	Black
Leg	Natural Wood	Dark Wood

Product Code

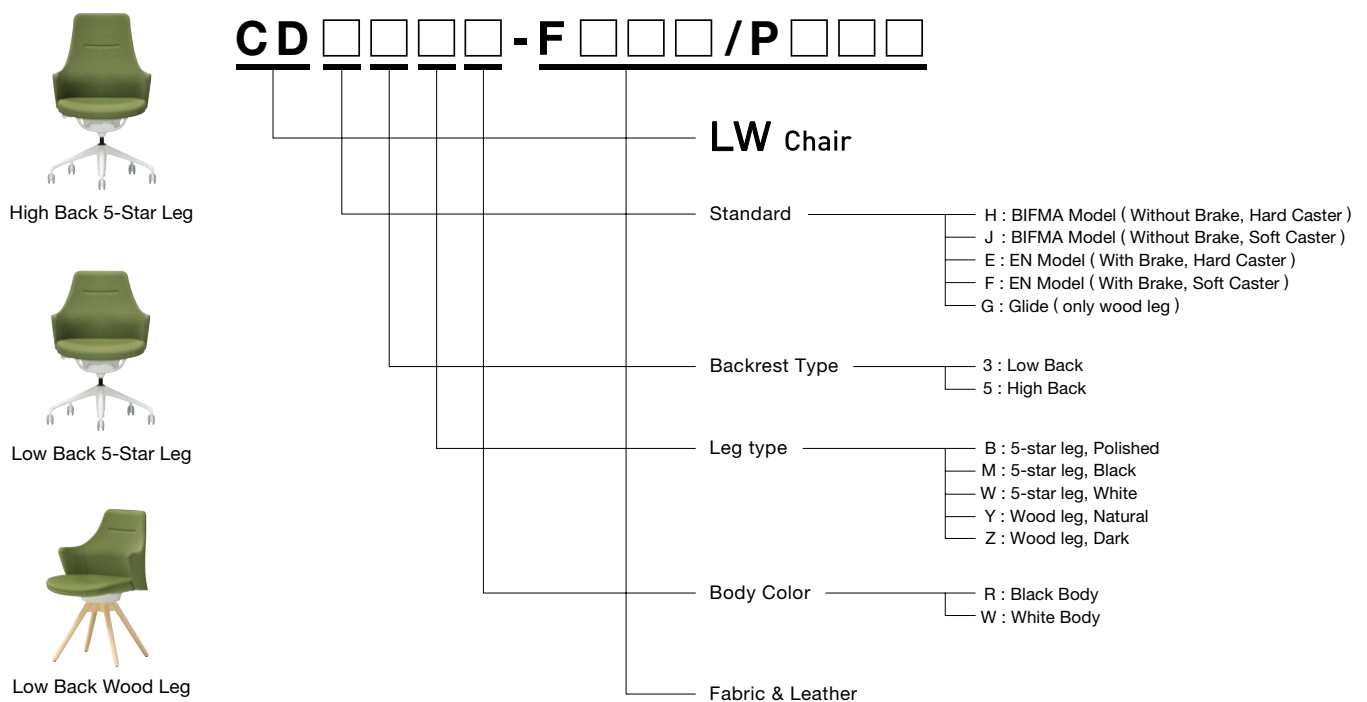

LW Lounge Chair

Armrest types



Without Armrest



With Armrest



With Armrest & Tablet

Base types



White Ring Base



Natural Wood Base



Black Ring Base



Dark Wood Base

Product Code



With Work Veil



Extra High Back



Mid Back

L14 **N-F** / **P**

LW Lounge Chair

Armrest type — 3 : Without Armrest
7 : With Armrest
9 : With Armrest & Tablet

Backrest type — H : High Back
E : Extra High Back
W : Extra High Back with Work Veil

Base type — R : Black Ring Base , Black Body
S : Dark Wood Base , Black Body
W : White Ring Base , White Body
Z : Natural Wood Base , White Body

Fabric & Leather Colors

LW Chair

Color Variations

Twill

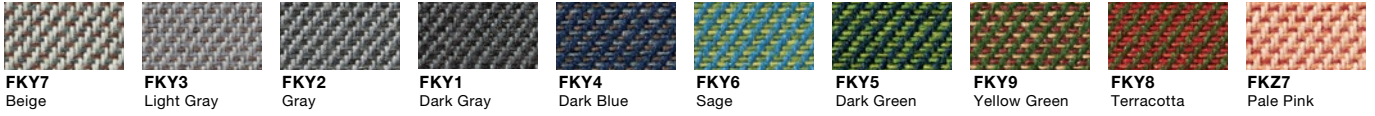

Twill (Two-toned)

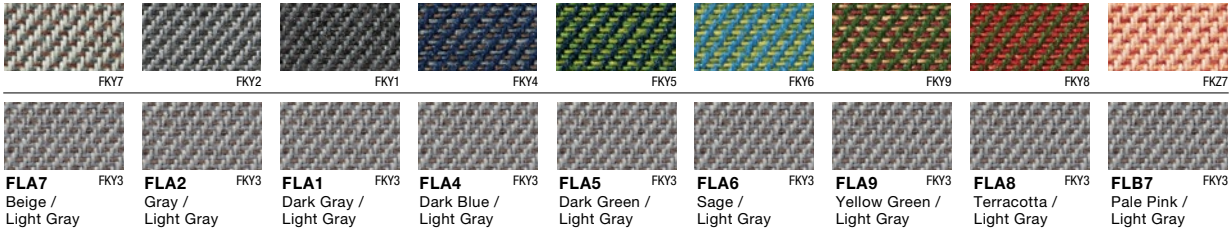

Interlock



Leather



LW Lounge Chair

Color Variations

Twill

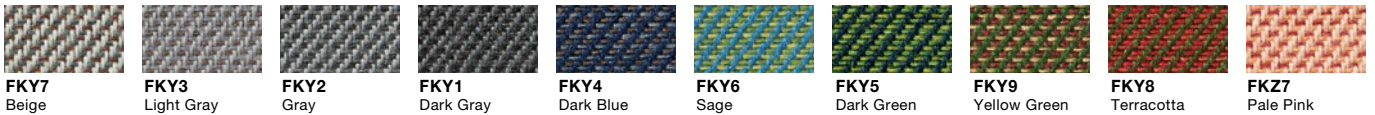

Interlock



Leather



Color Variations **kvadrat** (Special Fabric)

Steelcut Trio

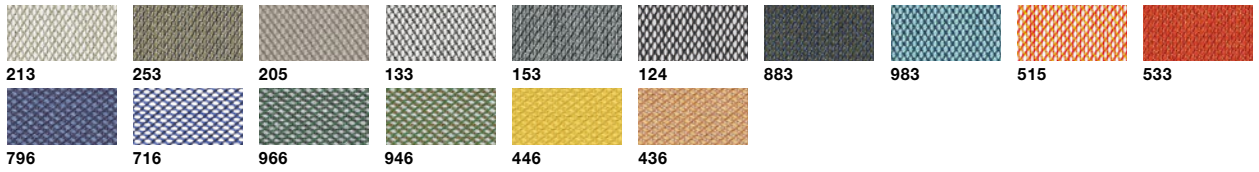

Remix

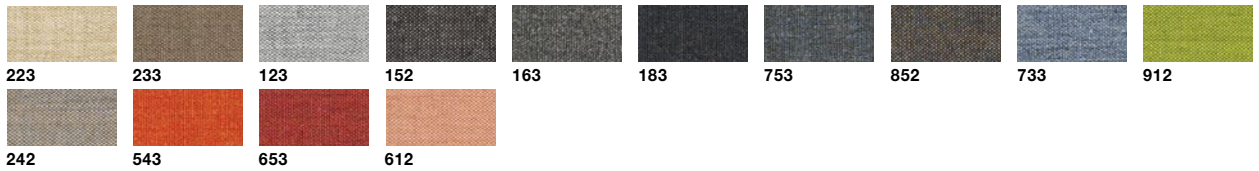

Umami3

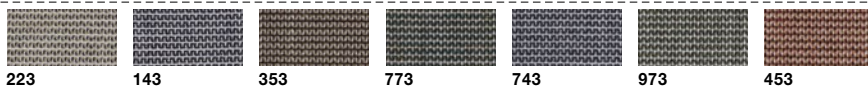

Divina MD



Divina

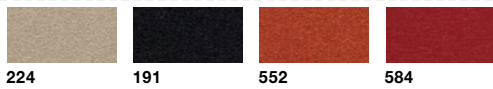

Revive1

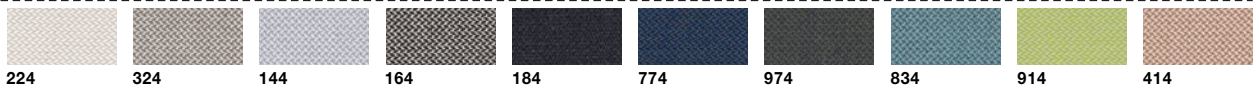

Recheck

※ Only LW Chair



Color Variations **Japan-made** (Special Fabric)

N.C.



LW Chair	
Chair Type	
High Back 5-Star Leg	
Low Back 5-Star Leg	
Low Back Wood Leg	

LW Lounge Chair		
Chair Type	Armrest Type	
With Work Veil	With Arm	
	With Tablet	
Extra High Back	Without Arm	
	With Arm	
Mid Back	Without Arm	
	With Arm	
	With Tablet	
	Without Arm	