

Portone



okamura



Design that flexibly supports your best posture.



The union of style and comfort.
The pliable frame harmonizes with your movement
as the lumbar support comfortably contours the curves of your back.
A design born of Okamura's fascination with ergonomics.

Portone

Color your own.



2 body colors, 3 mesh tones, 23 seat colors, 3 base finishes.
Available in sophisticated neutrals or with a tasteful color accent.





Pliable Frame

The backrest flexes with the motion of your body. The bend comfortably accommodates natural side-to-side movement.

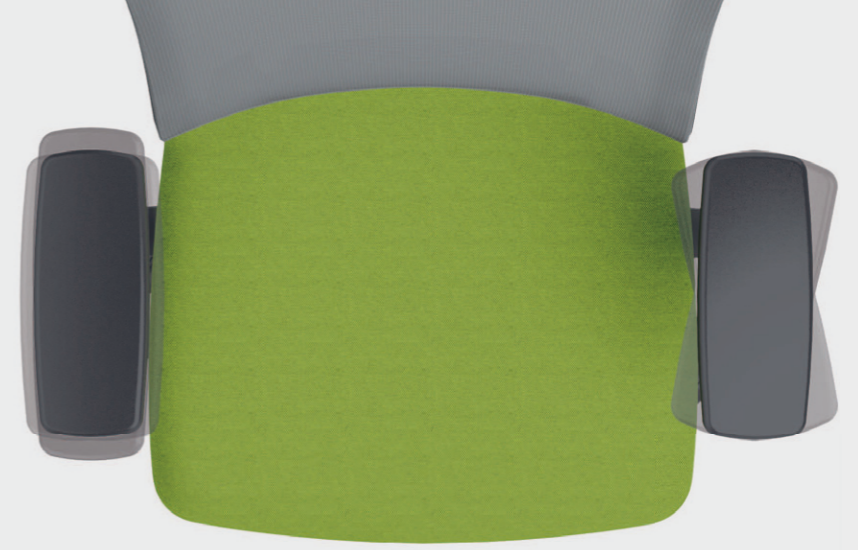

Adjustable Arms (1D/4D Arms)

1D and 4D adjustable arms easily adjust up and down. 4D adjustable arms also twist inward and outward and slide forward, backward, right and left.

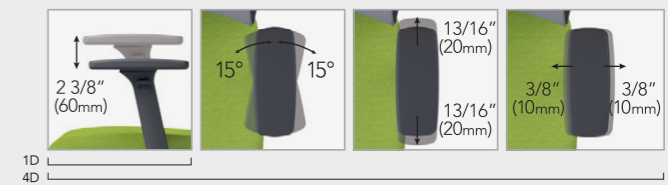

Adjustable Lumbar Support

The supple lumbar support fortifies your body's core, reinforcing a healthy posture.



The lumbar support easily adjusts to match your physical requirement. To adjust, simply grasp the lower ridge of the lumbar support and push up or down.

Headrest



Headrest height can be adjusted by sliding up (range : 2").

Adjustable Seat Height

Adjust the height of the seat by pulling up the lever under the seat on the right (range : 4 3/4").



Adjustable Seat Depth

Adjust the depth of the seat by operating the lever on the left of the seat (range : 2 3/16").

Reclining

1 Redlining Tension Adjustment

Redlining tension can be adjusted by rotating the dial under the center of the seat. Turn clockwise to increase tension, or counterclockwise to reduce tension.

2 Lock and Release of Backrest

The backrest can be locked (in upright position only) by pushing in the lever under the seat. To release, simply pull the lever out.

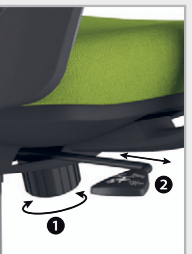

Back Colors



Seat Colors

Era (Camira)

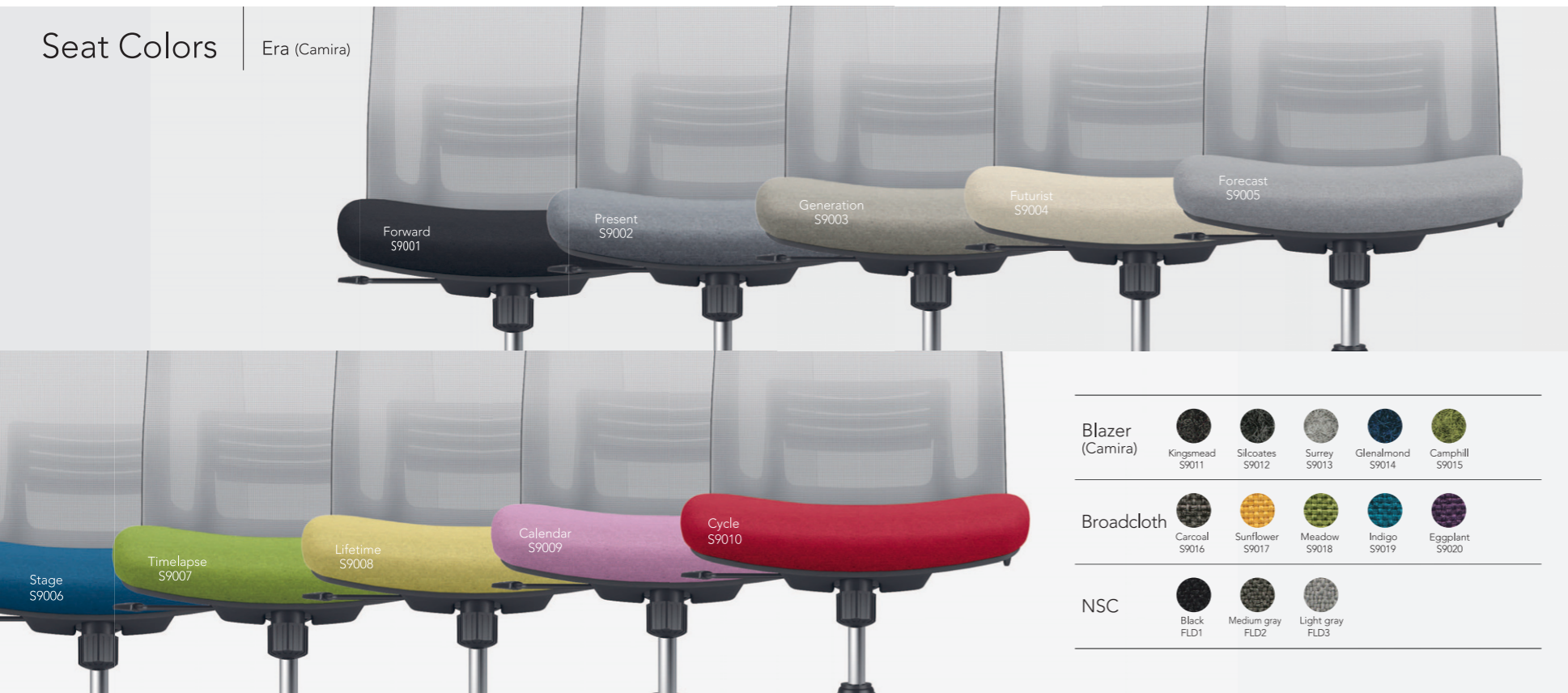

Blazer (Camira)	Kingsmead S9011	Silcoates S9012	Surrey S9013	Glenalmond S9014	Camphill S9015
Broadcloth	Carcoal S9016	Sunflower S9017	Meadow S9018	Indigo S9019	Eggplant S9020
NSC	Black FLD1	Medium gray FLD2	Light gray FLD3		

Armrest Type



Base Type



Back Height



Measurement

High Back

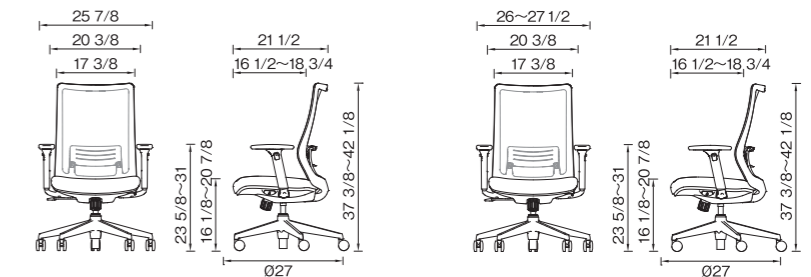

Extra High Back

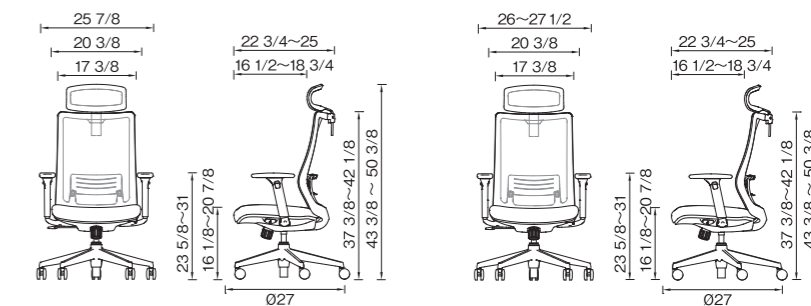

okamura

OKAMURA CORPORATION

International Sales & Marketing Div.

2-14-27, Akasaka, Minato-ku, Tokyo 107-0052, JAPAN

Tel: +81-3-5561-4085 Fax: +81-3-5561-4086

<http://www.okamura.jp/>

The products listed in this catalog are available as of October 2017. Please note that specifications, dimensions, and colors are subject to change without notice. The colors of the actual products may differ somewhat from the colors shown in the catalog, depending on printing conditions.

YOCK40-7N1 RSG '17-10 Printed in Japan