

Zart

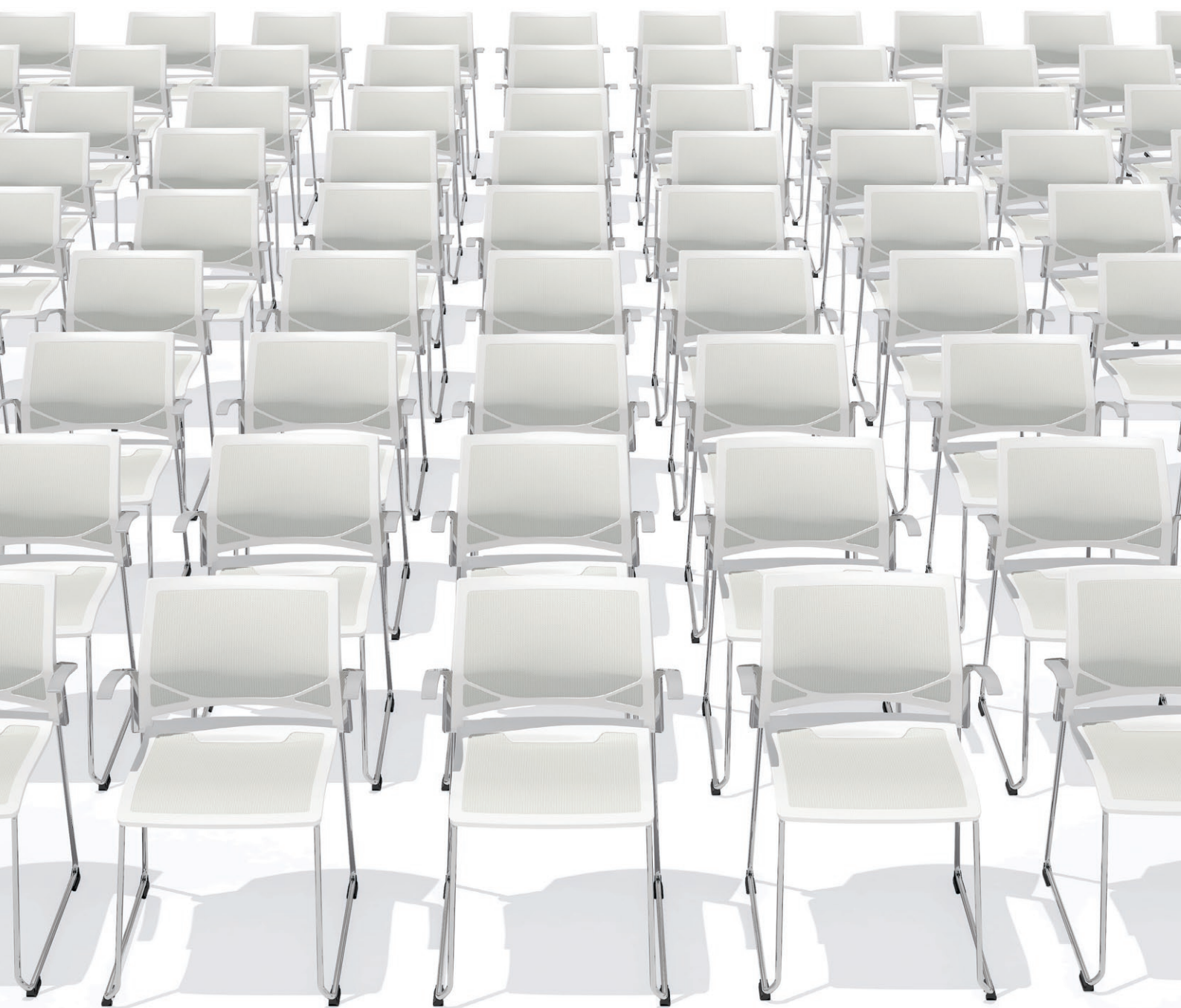

okamura

Zart

Versatile meeting chairs offering maximum comfort

The Zart chair features a unique design that is simple yet stylish. A newly developed mesh material cradles the body in supreme comfort. Zart brings lightness and beauty to all office spaces.





01

Seminar Rooms

Experience a lightness of form that is both beautiful and functional.

An elastic mesh seat and backrest guarantees comfort, helping to create inspirational seminar spaces.



02

Large Conference Rooms

A focus on materials and quality achieves both comfort and top performance. We support creativity and enhanced communication for all conference members in every meeting scenario.

04

Small Conference Rooms

This simple form can be applied flexibly for all meeting types. The understated design heightens concentration and supports constructive and productive meetings.

03

Public Spaces

This plain form creates a clean impression, with calming colors. Soft and comfortable seating creates refreshingly relaxing amenity spaces.

Swivel models

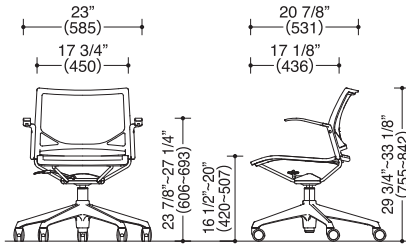

23"W×20 7/8"D×16 1/2"-20"SH·29 3/4"-33 1/8"H
(585W×531D×420-507SH·755-842H)
Weight / With arm: 10.8kg

27 3/8"
(696)
inch (mm)

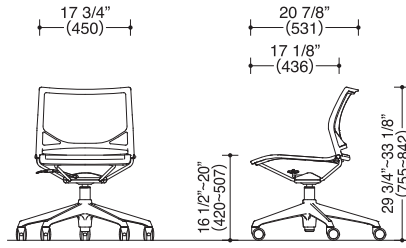

17 3/4"W×20 7/8"D×16 1/2"-20"SH·29 3/4"-33 1/8"H
(450W×531D×420-507SH·755-842H)
Weight / Without arm: 9.6kg

27 3/8"
(696)
inch (mm)

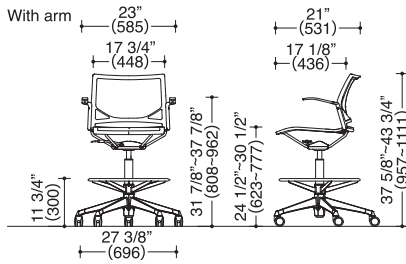

With arm
23"W×21"D×24 1/2"-30 1/2"SH·
37 5/8"-43 3/4"H
(585W×531D×623-777SH·957-1111H)
Weight / 13.8kg

Without arm
17 3/4"W×21"D×24 1/2"-30 1/2"SH·
37 5/8"-43 3/4"H
(448W×531D×623-777SH·957-1111H)
Weight / 12.6kg

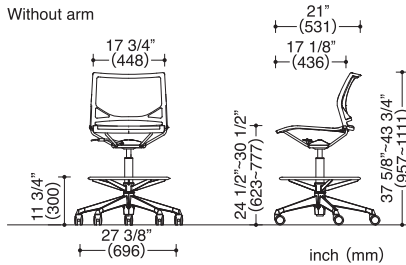

New elastic mesh material



This new mesh material features the woven fabric construction. It ensures excellent cushioning in the backrest and seating face for soft and comfortable seats.

Mesh colors:

Black Shell



Black
FZF1



MediumBlue
FZF2



LimeGreen
FZF3



Red
FZF4



MediumGray
FZF5



Sage
FZF6



Yellow
FZF7



LightBlue
FZF8

White Shell



LimeGreen
FZF3



Sage
FZF6



Yellow
FZF7



LightBlue
FZF8



White
FZF9

Stackable models

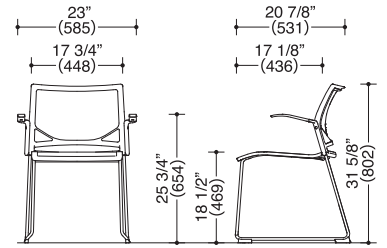

23"W×22 5/8"D×18 1/2"SH·31 5/8"H
(585W×573D×469SH·802H)
Weight / With arm: 5.4kg

21 1/8"
(535) 22 5/8"
(573)
inch (mm)

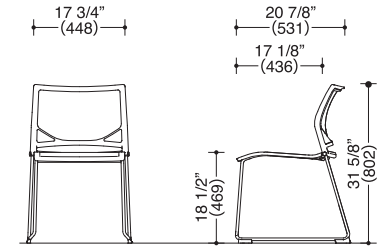

17 3/4"W×22 5/8"D×18 1/2"SH·31 5/8"H
(448W×573D×469SH·802H)
Weight / Without arm: 4.2kg

21 1/8"
(535) 22 5/8"
(573)
inch (mm)



Chairs with arms cannot be ganged together.

Up to 30 chairs can be stacked.

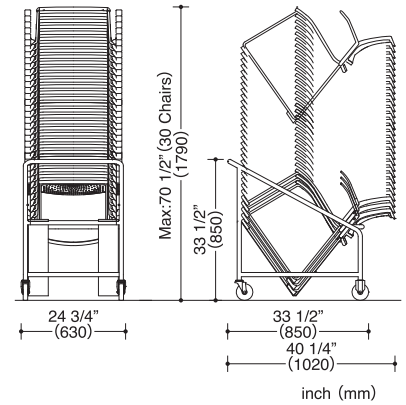

Ecology

■ Designed for Recycling
Designed for ease in separate materials for recycling.

■ Designed for Longevity
The back and seat can be replaced separately, making for easy maintenance and a long service life.

■ Ample Use of Recycled Resins
Recycled resins are amply utilized to help make effective use of existing resources.



okamura

OKAMURA CORPORATION
International Sales & Marketing Div.

2-14-27, Akasaka, Minato-ku, Tokyo 107-0052, JAPAN
Tel: +81-3-5561-4085 Fax: +81-3-5561-4086

<http://www.okamura.jp/>

The products listed in this catalog are available as of February 2017. Please note that specifications, dimensions, and colors are subject to change without notice. The colors of the actual products may differ somewhat from the colors shown in the catalog, depending on printing conditions.